



**S.P.B. PATEL  
ENGINEERING COLLEGE**  
SAFFRONY INSTITUTE OF TECHNOLOGY CAMPUS

Near Shanku's Water Park,  
Ahmedabad – Mehsana Highway,  
Linch, Mehsana – 384435  
Email: info@saffrony.ac.in  
Web: www.saffrony.ac.in  
Phone : (02762) 285721



**CYCLE 1  
NAAC Accreditation 2023**

# ACADEMIC YEAR 2021-22

*Submitted to*



---

**NATIONAL ASSESSMENT AND ACCREDITATION COUNCIL**

**6.3.3 Percentage of teaching and non-teaching staff participating in Faculty development Programmes (FDP), Management Development Programmes (MDPs) professional development /administrative training programs during the last five years**

**Academic Year 2020-21**

Sr. No.	Name of the participant	Title of the FDP /MDP/ professional development / administrative training program	Dates (from-to) (DD-MM-YYYY)
1	Kushal Bhardwaj	Research and Innovate with 3D Printing	02-08-2021 to 06-08-2021
2	Upasanaben Pingalashibhai Leela	MDP-CERTIFICATE PROGRAM	6-8 Sep 2021
3	Sangitaben Rameshchandra Lakhara	MDP-CERTIFICATE PROGRAM	6-8 Sep 2021
4	Joseph Sebastian Sibi	MDP-CERTIFICATE PROGRAM	6-8 Sep 2021
5	Dixa Nareshbhai Koradia	MDP-CERTIFICATE PROGRAM	6-8 Sep 2021
6	Meet Manishkumar Jani	MDP-CERTIFICATE PROGRAM	6-8 Sep 2021
7	Poojan Vipulbhai Shah	MDP-CERTIFICATE PROGRAM	6-8 Sep 2021
8	Jaiminkumar Gunvantbhai Suthar	MDP-CERTIFICATE PROGRAM	6-8 Sep 2021
9	Nishi Prakash Patwa	MDP-CERTIFICATE PROGRAM	6-8 Sep 2021
10	Dr. Gaurav Gaurang Joshi	MDP-CERTIFICATE PROGRAM	6-8 Sep 2021
11	Chirag Mukeshbhai Korat	MDP-CERTIFICATE PROGRAM	6-8 Sep 2021
12	Devarshi Dave	MDP-CERTIFICATE PROGRAM	6-8 Sep 2021
13	Mansi Devendrabhai Shah	MDP-CERTIFICATE PROGRAM	6-8 Sep 2021
14	Bhavik Rasikbhai Patel	MDP-CERTIFICATE PROGRAM	6-8 Sep 2021
15	Sagar Ramjibhai Thummar	MDP-CERTIFICATE PROGRAM	6-8 Sep 2021
16	Nishant Makadia	MDP-CERTIFICATE PROGRAM	6-8 Sep 2021
17	Ekta Pran Shanker Joshi	MDP-CERTIFICATE PROGRAM	6-8 Sep 2021

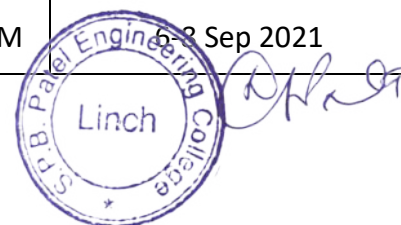

Sr. No.	Name of the participant	Title of the FDP /MDP/ professional development / administrative training program	Dates (from-to) (DD-MM-YYYY)
18	Ravi Prakashbhai Dal	MDP-CERTIFICATE PROGRAM	6-8 Sep 2021
19	Tushar Himanshubhai Panchal	MDP-CERTIFICATE PROGRAM	6-8 Sep 2021
20	Jigneshkumar Vishnubhai Kadia	MDP-CERTIFICATE PROGRAM	6-8 Sep 2021
21	Nirav Ratilal Joshi	MDP-CERTIFICATE PROGRAM	6-8 Sep 2021
22	Chetankumar Rameshbhai Mordiya	MDP-CERTIFICATE PROGRAM	6-8 Sep 2021
23	Kapil Kantibhai Dayma	MDP-CERTIFICATE PROGRAM	6-8 Sep 2021
24	Akhil Venkat Patnaik	MDP-CERTIFICATE PROGRAM	6-8 Sep 2021
25	Kishan Ajaykumar Vaghela	MDP-CERTIFICATE PROGRAM	6-8 Sep 2021
26	Rajkumar Tarachand Rajai	MDP-CERTIFICATE PROGRAM	6-8 Sep 2021
27	Jaimin Harshadray Jani	MDP-CERTIFICATE PROGRAM	6-8 Sep 2021
28	Prashant Bhagwan Parashar	MDP-CERTIFICATE PROGRAM	6-8 Sep 2021
29	Anurag Rajender Chandnani	MDP-CERTIFICATE PROGRAM	6-8 Sep 2021
30	Dr. Narshi Khodabhai Sherasia	MDP-CERTIFICATE PROGRAM	6-8 Sep 2021
31	Kunalsinh Ranjitsinh Kathia	MDP-CERTIFICATE PROGRAM	6-8 Sep 2021
32	Dr. Pooja Jayeshbhai Mehta	MDP-CERTIFICATE PROGRAM	6-8 Sep 2021
33	Jay Paragbhai Parikh	MDP-CERTIFICATE PROGRAM	6-8 Sep 2021
34	Avinash Vikrambhai Patel	MDP-CERTIFICATE PROGRAM	6-8 Sep 2021
35	Palak Rajeshbhai Godhani	MDP-CERTIFICATE PROGRAM	6-8 Sep 2021
36	Yashkumar Pareshbhai Patel	MDP-CERTIFICATE PROGRAM	6-8 Sep 2021
37	Dr. Arun Shreeprakash Pandey	MDP-CERTIFICATE PROGRAM	6-8 Sep 2021
38	Jagdish Mohanbhai Mevada	MDP-CERTIFICATE PROGRAM	6-8 Sep 2021

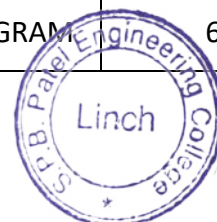

Sr. No.	Name of the participant	Title of the FDP /MDP/ professional development / administrative training program	Dates (from-to) (DD-MM-YYYY)
39	Chintan Tuljashankar Mehta	MDP-CERTIFICATE PROGRAM	6-8 Sep 2021
40	Utsav Minesh Shah	MDP-CERTIFICATE PROGRAM	6-8 Sep 2021
41	Pranoti Chandrashekhar Kale	MDP-CERTIFICATE PROGRAM	6-8 Sep 2021
42	Nisarg Vijaykumar Prajapati	MDP-CERTIFICATE PROGRAM	6-8 Sep 2021
43	Tausif Shaikh	Current Field Practices for Energy and Utility Systems	06-12-2021 to 10-12-2021
44	Divyang Patel	ATAL FDP on Electric & Hybrid Vehicles	27-12-2021 to 31-12-2021
45	Avani Dedhia	Guidance and Counselling	17-01-2022 to 21-01-2022
46	Meet Jani	Facilitating Digital Transformation in Design, Construction and Management Processes of Civil Engineering	21-02-2022 to 02-03-2022
47	Prof. Niraj Sorathiya	ATAL FDP on Robotics	20-12-2021 to 25-12-2021

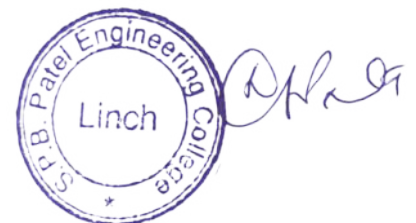



**S. P. B. PATEL  
ENGINEERING COLLEGE**

SAFFRONY INSTITUTE OF TECHNOLOGY CAMPUS

17<sup>th</sup> August 2021

**Report on**

**FDP**

**Research and Innovate with 3D Printing**

FDP by Mrs. Parimala Murugaveni S,  
Government College of Technology,  
Coimbatore

**Prepared By:**

**Prof. Kushal Bhardwaj**

Mechanical Engineering Department

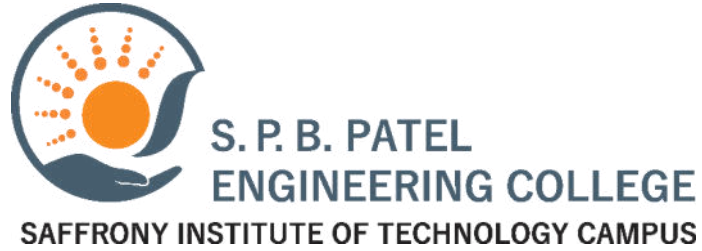

## **Report on Research and Innovate with 3D printing**

**Name of Participant:** Prof. Kushal Bhardwaj (Mechanical Engineering Department)

**Role:** Participant

**Name of Resource Person:** Mrs. Parimala Murugaveni S

**Organized by:** Government College of Technology, Coimbatore

**Date:** 2nd August 2021 to 6th August 2021

**Duration:** 9AM to 4:00 PM

**Venue:** Online (Zoom Meetings)

**No. of Participants:** 76+ Faculty Members

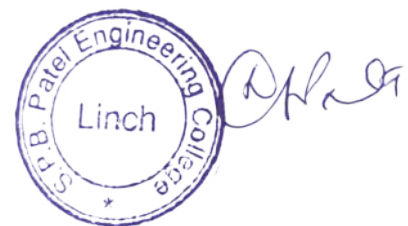

Date: 02.08.2021

Day: Monday

Time: 9.30 am-11.00am

Speaker: Dr. Rajesh Ranganathan Professor, Department of Mechanical Engineering, Coimbatore Institute of Technology, Coimbatore

Topic: Research Exploration in Additive Manufacturing

Summary: It started with the prediction's vs actual development of technological growth over the past few decades. About RP, the following points were summarized:

- Stages of RP
- The inputs which can be given for RP which are: 3D cad design, 2D cad drawing/manual outline/ Lattice Data, point cloud data, reverse engineering, Data acquired from MRI or CT scan, etc.
- Detailed explanation about photocoagulation and indirect ophthalmoscopy using 3D model. 3D prototype can be created and the same can be used by practicing surgeons. In this, actual problem was analyzed, new design was suggested, re-engineering was done, simulation of newly created model was carried out, and final cost comparison was done with all 3 types of model namely rigid, semi-flexible and flexible.
- Still a lot of scope is present in this area.

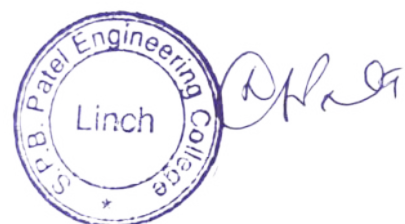
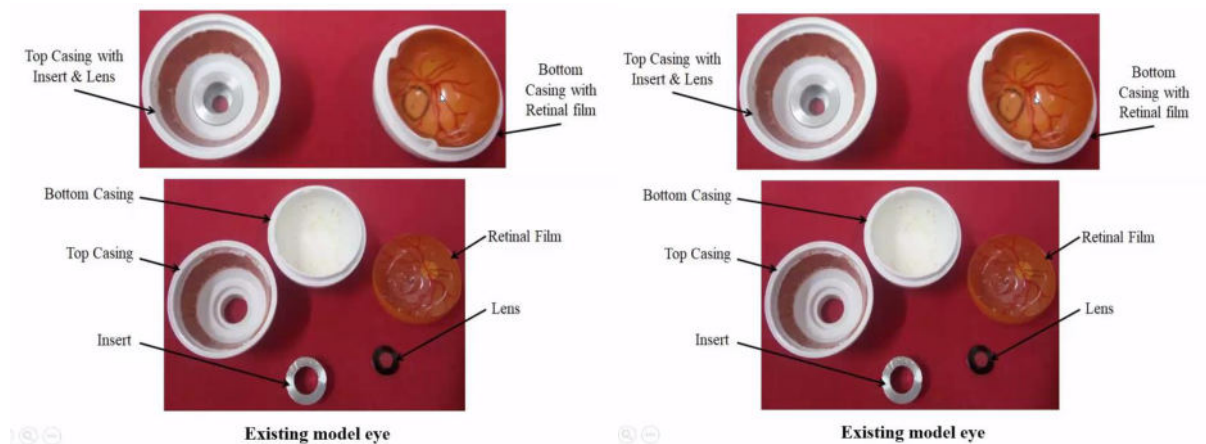

Date: 02.08.2021

Day: Monday

Time: 11.00am -1.00 pm

Speaker: Abhay Karandikar, Mamta Rani Aggarwal, etc.

Topic: INAGURATION by ATAL

Summary:

- Out of every 6 people on earth, 1 is Indian.
- So, working on team to integrate and provide best to our country.
- Many building/ rooms and infrastructure are in construction stage, so that we can come and meet for upcoming sessions in cities like Haryana, Sonipat, Bhopal, Assam, Guwahati, etc.
- 1 million students are passed out every year in engineering field.
- Vast difference between what are accepted vs what is delivered.
- So, there was inclusion of internships, teacher building, etc to increase quality of engineers produced.
- They are going to announce several country head for each domain in coming days.

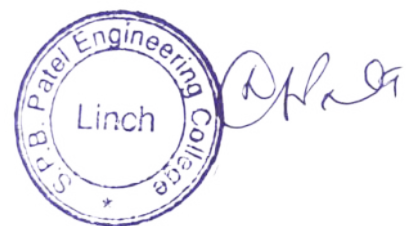



Date: 02.08.2021

Day: Monday

Time: 2.00pm -4.15 pm

Speaker: Dr. Mohammad Taufik Maulana Azad National Institute of Technology, (An Institute of National Importance) Bhopal, Madhya Pradesh.

Topic: Design for Additive Manufacturing

Summary:

- Used 3D printing technology to create face shields during covid, 3D printed arm/elbow operated water tap handle, ventilator parts in covid pandemic.



- Basic's RP processes like FDM, SLS and SLA were discussed.
- Tessellation of 3D model geometry, ASCII vs Binary format in .STL format
- Discussed importance of part orientation while printing along with some common errors in printing.
- Introduction to software used in 3d printing, necessity of support structures, self-balancing support structures, examples of prototype, rapid tooling.

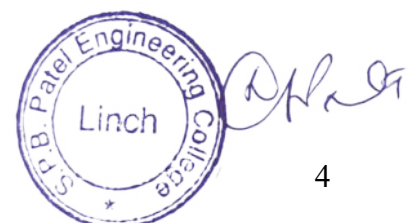

Date: 03.08.2021

Day: Tuesday

Time: 9.30 am-11.00am

Speaker Mr.Charath Chander Natarajan, Co-Founder MaxCADD, Coimbatore.

Topic: All about FDM

Summary:

- FDM technology was started by Scott and Lisa Trumph in 1988
- Adrian Bowyer created 1<sup>st</sup> 3D printer from 3D printer machine
- types of FDM – Cartesian, delta, SCARA
- World's 1<sup>st</sup> 3d printed bridge- at Amsterdam
- Various components of 3D printer like Firmware, Hardware and Slicing software were discussed.
- Some common problems & some future scope along with learning science kits for kids were discussed in brief



## Books Related to Innovation

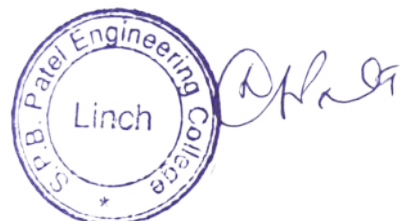

Date: 03.08.2021

Day: Tuesday

Time: 11.30am -1.00 pm

Speaker: Mr.Mohan Nivas N, Founder Tai Technologies Industrial Solution, Erode

Topic: Design thinking product development

Summary: 5 elements of design thinking – empathize, define, ideate, prototype and test iterate with an example.

# Design Thinking

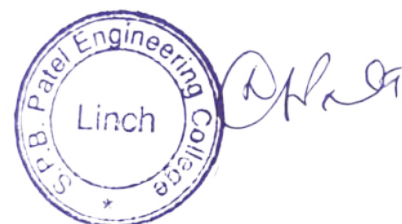
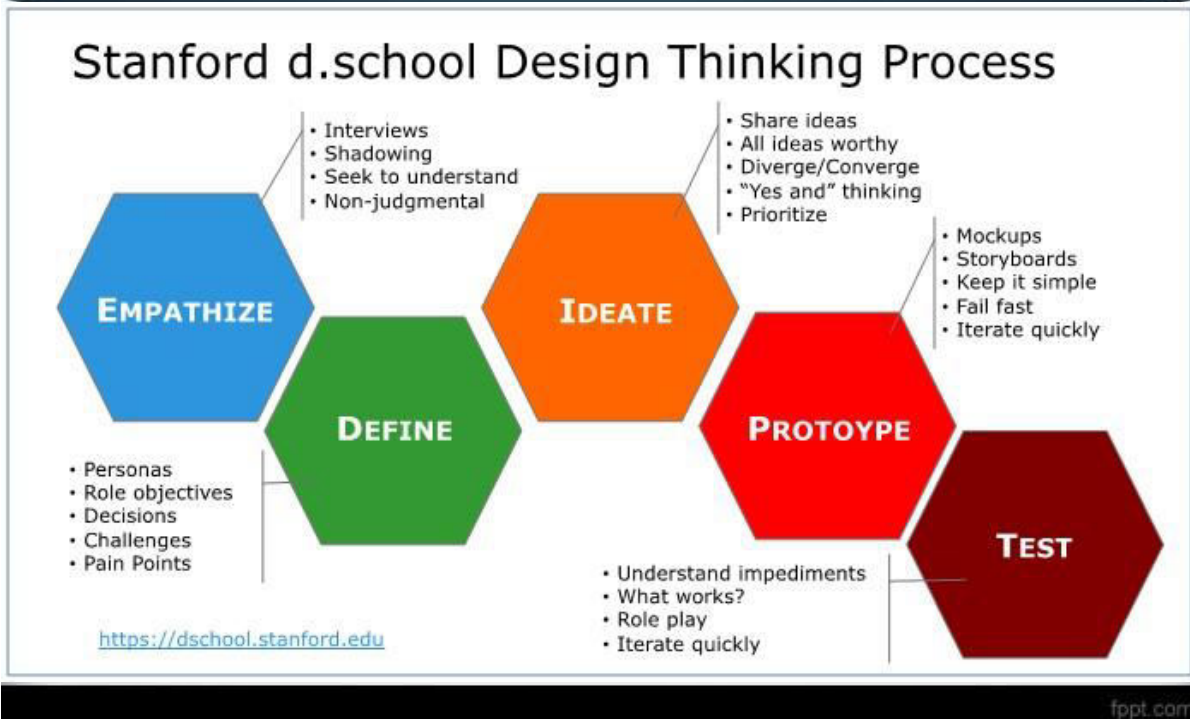

Date: 03.08.2021  
 Day: Tuesday  
 Time: 2.00pm -4.00 pm  
 Speaker: Dr. Mohammad Taufik Maulana Azad National Institute of Technology Bhopal,  
 Madhya Pradesh  
 Topic: Post-Processing Techniques of Additively Manufactured Parts

Summary:

- There are critical issues of mechanical and surface properties in RP depending upon the manufacturing process
- Post Processing treatments are Mechanical, chemical, irradiation & Thermal.
- Following table summarizes the work done to improve surface finish along with year.

Year	Work
2000	Integration of layered manufacturing and material removal processes
2004	Rapid planning for CNC milling- a new approach for rapid prototyping
2005	Concave edge-based part decomposition for hybrid rapid prototyping
2006	Virtual hybrid-FDM system to enhance surface finish
2009	Experimental study aiming to enhance the surface finish of fused deposition modelled parts
2010	Quantitative analysis of a chemical treatment to reduce roughness of parts fabricated using fused deposition modelling
2015	Surface roughness improvement of cast components in vacuum moulding by intermediate barrel finishing of fused deposition modelling patterns
2015	Roughness prediction in coupled operations of fused deposition modelling and barrel finishing
2016	Post processing for Fused Deposition Modelling Parts with Acetone Vapour Bath
2016	Polishing mechanism for ABS parts fabricated by additive manufacturing
2016	Finishing of Fused Deposition Modelling parts by CNC machining

- In detail calculation for surface improvement was presented.
- Comparison of surface finish for various post processing work were compared.

Date: 04.08.2021

Day: Wednesday

Time: 9.30 am-11.00am

Speaker Mr.Iraimudi V, Head-Healthcare, Shree Rapid Technologies, Coimbatore.

Topic: Medical Application of Additive Manufacturing

Summary:

- Shree Rapid Technology – The only company that offers complete digital Solution for Healthcare.
- There are several areas in our body where the RP technology can be used in medical field.
- The whole procedure can be summarized as below:

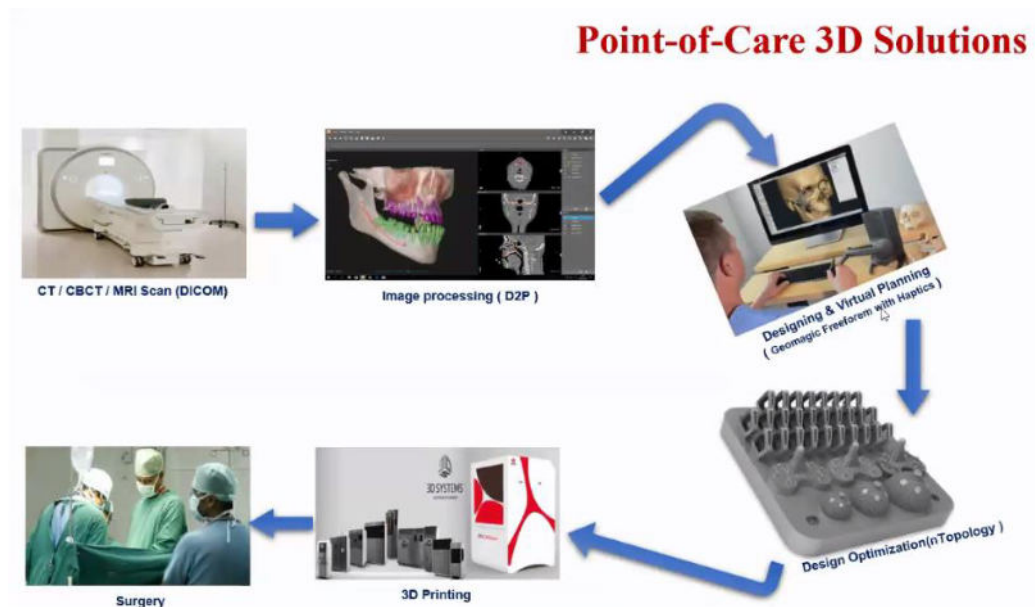

- D2P software can take input directly from CT scanner and work ahead. Software allows basic editing options in model.
- There are lot of sectors in which this technology is being used like Aerospace, defense, Automobile, Consumer products, etc.
- Materials used were MED-WHT 10 – which is biocompatible and sustainable at high temperature. Various printers are available which can print colorful models also.

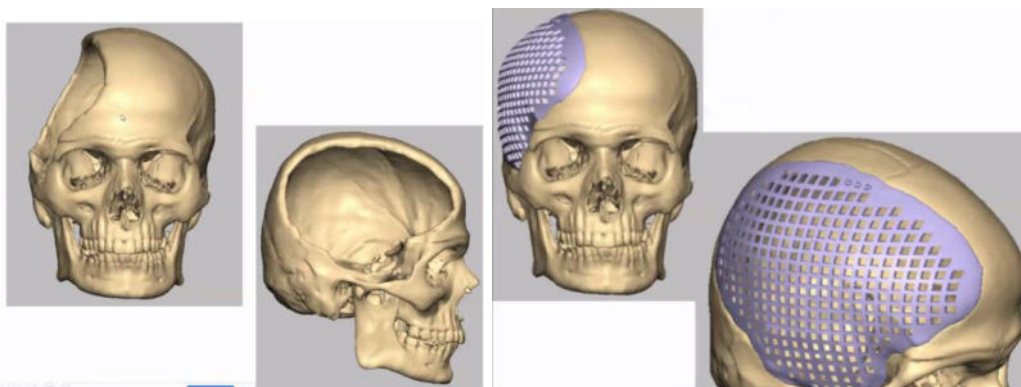

Date: 04.08.2021

Day: Wednesday

Time: 11.30am -1.00 pm

Speaker: Dr.V. Anilkumar Scientist SF, MPA/MME, VSSC ISRO, Trivandrum

Topic: Metal Additive Manufacturing; Recent Advances and Future Trends

Summary:

- Introduction to Industry 4.0
- Approximately in every 18 months, the technology changes. The power of chips bandwidth and computer doubles approximately in 18 months.
- Introduction to AM, classification, benefits, materials, applications, Comparison between Conventional Manufacturing vs 3D printing wrt no of parts manufactured.
- Wire Arc Additive manufacturing -about, features, components, and comparison
- Limitations, geometrical capacities and Thermal Stress in Laser Powder Bed Fusion.
- Below figure shows the different applications,

### Metal AM for Space :World Scenario

ISRO ISRO

Many Aerospace companies have included AM in Supply chains

ISRO:North West feed cluster assembly of GSAT-19

SpaceX: SuperDraco Engine and Merlin Engine MOV

ESA: Propulsion module for Ariane-6

Lockheed Martin: Satellite Propellant Tank

Relativity Space: Propellant Tanks

Skyroot: Dhawan-I Cryogenic Engine

Rocket Lab: Rutherford Engine

Franhoufer IWS: Aerospike Nozzle

Cellcore: Engine Chamber

Fuel Tank (Relativity Space)

Dhawan-I (Skyroot)

Rutherford Engine (Rocket Lab)

Aerospike Nozzle (Franhauser IWS)

Engine Chamber (Cellcore)

Fuel Cluster

Satellite Tank Dome (Lockheed Martin)

Superdraco (SpaceX)

54

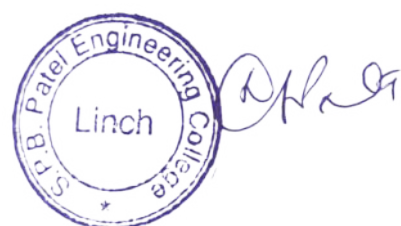

Date: 04.08.2021

Day: Wednesday

Time: 2.00pm -4.15 pm

Speaker: Dr. Vishal Francis Assistant Professor in the School of Mechanical Engineering, Lovely Professional University, Punjab.

Topic: 3D Printing of Nano Composite for Printed Electronics

Summary:

- Discussed steps involved from rapid prototyping to additive manufacturing.
- Importance and usage of 3D printed materials in aerospace applications with examples.
- Importance and usage of 3D printed materials in automobile industry with examples.
- General Additive Manufacturing process – steps, classification, importance of materials, Thermoplastic – Its advantages, disadvantages, TPU, etc.
- Addition of electric conducting filament in FFF, Printing of Flexible 3D Antenna using conductive ABS materials, use of dual extrusion concept for printed electronics, Characteristics of 3D Printed Flexible Materials.
- By controlling the voids in 3D printed structures, we can control dielectric constant. Similarly, sandwich type of structures with multi-layer of different materials can be prepared and its dielectric values can be obtained.
- Similarly, by varying layer thickness the voids size can be varied and the material properties can be varied.
- Use of Nano-clay Reinforced Composite for Fused Filament Fabrication, morphology and Thermal Properties of on-site nanocomposite.
- Comparison of Mechanical and surface property of Nano-clay

### Comparison of the Proposed Approaches

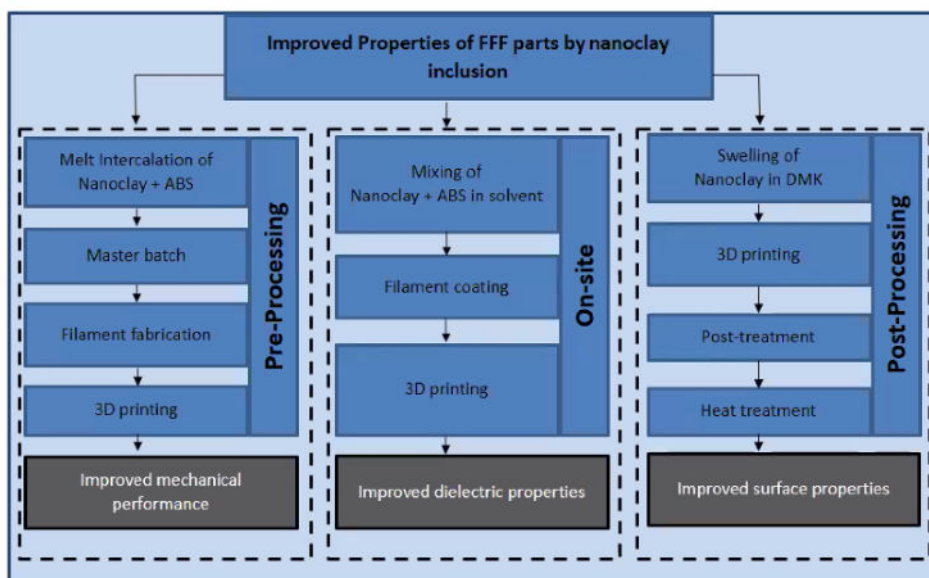

Date: 05.08.2021

Day: Thursday

Time: 9.30 am-11.00am

Speaker: Dr.Rajesh Ranganathan Professor, Department of Mechanical Engineering, Coimbatore Institute of Technology, Coimbatore.

Topic: Developing innovation products through Additive Manufacturing

Summary:

- For babies born with deformities, there is a requirement of unique shaped counter body parts, so 3D printing is used in it.
- A customized leg was designed for a child with disability.

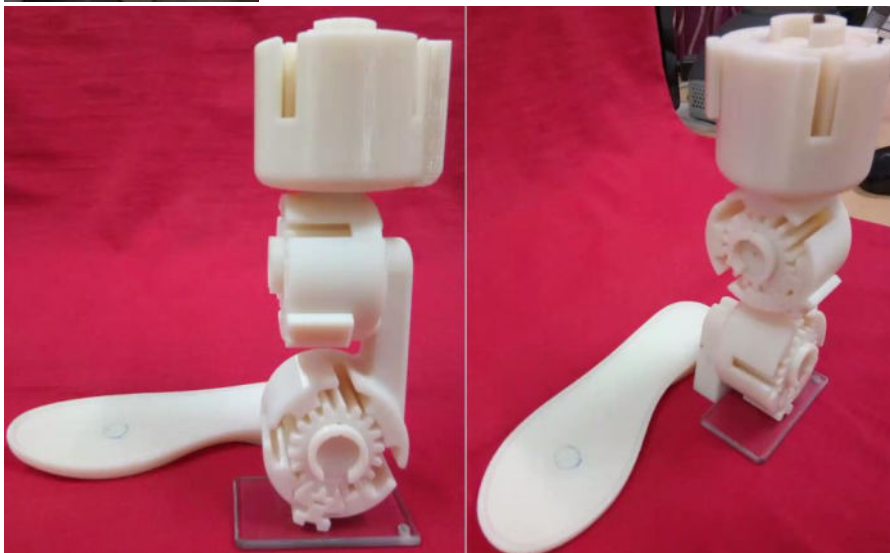
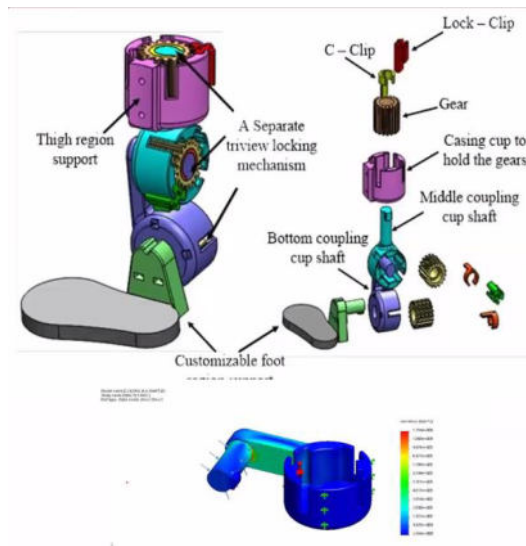

- Diabetes in India is at peak. Due to diabetes, one leg is lost every 20 second in the world. It starts with ulcer in feet and then develops further. So the idea was to design a diabetic foot insole customized for every patient. Pressure generated at feet while walking was measured by a machine and accordingly a foot console was designed to reduce pressure points.



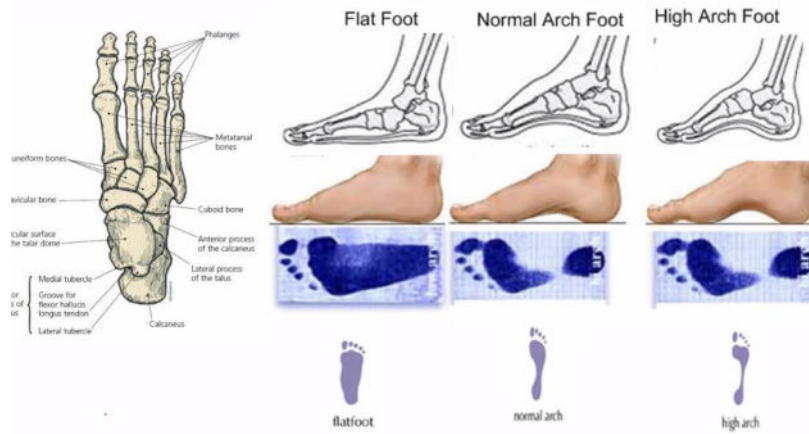

- In case of major surgery in patient body, they developed an identical 3D prototype, so that doctors can practice in prototype properly and then perform actual operation.
- For coma patients, each bed needs to be designed as special for each patient considering their body weight and shape. These beds are not reusable for next patient. So, they designed a bed using 3D printing technology which can be recycled for about 15 times along with sterilization.

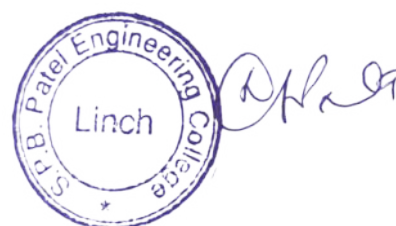

Date: 05.08.2021

Day: Thursday

Time: 11.30am -1.00 pm

Speaker: Dr T Ram Prabhu Deputy Director / Scientist Expertise: Materials and Manufacturing Engineering for Aerospace Applications Defence R&D Organization.

Topic: Project Proposals ideas in Metal Additive Manufacturing for funding bodies

Summary:

- In aerospace application there are a lot of frame work construction, similarly the parts used in automobile have much complexity and are difficult to manufacture using traditional process, so to over come this difficulty, we can use AM process.
- Laser bed Fusion LBF – introduction, advantages, challenges, solutions
- AL alloys, Titanium alloys and superalloys – grades, microstructure, density, tensile, hardness, bending, mechanical properties, heat treatment, hot mapping, solidification, porosity, fatigue, hardness, wear, oxidation, friction properties, etc. were discussed in detail.

Table 1. Various AM technologies for processing of titanium and its alloys.

AM Category	Technology	Company	Description
Directed Energy Deposition (DED)	Direct Metal Deposition (DMD)	DMDD Technology LLC (Formerly POM Group)	Uses laser and metal powder for melting and depositing using a patented close loop process.
	Laser Engineered Net Shaping (LENS)	Optomec, Inc.	Uses laser and metal powder for melting and depositing.
	Direct Manufacturing (DM)	Sciaky, Inc.	Uses electron beam and metal wire for melting and depositing.
	Shaped Metal Deposition or Wire and Arc Additive Manufacturing (WAAM)	Not commercialized yet (patented by Rolls Royce Plc.)	Uses electric arc and metal wire for melting and depositing.
Powder Bed Fusion (PBF)	Selective Laser Sintering (SLS)	3D Systems Corp. (acquired Phenix Systems)	Uses laser and metal powder for sintering and bonding.
	Direct Metal Laser Sintering (DMLS)	EOS GmbH	Uses laser and metal powder for sintering, melting and bonding.
	Laser Melting (LM)	Renishaw Inc.	Uses laser and metal powder for melting and bonding.
	Selective Laser Melting (SLM)	SLM Solutions GmbH	Uses laser and metal powder for melting and bonding.
	LaserCUSING	Concept Laser GmbH	Uses laser and metal powder for melting and bonding.
	Electron Beam Melting (EBM)	Arcam AB	Uses electron beam and metal powder for melting and bonding.

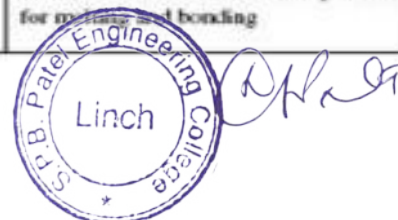

Date: 05.08.2021

Day: Thursday

Time: 2.00pm -4.00 pm

Speaker: Dr. Narendra Kumar, Assistant Professor Industrial and Production Engineering Department, Dr. B.R. Ambedkar National Institute of Technology, Grand Trunk Road, Bye pass, Jalandhar, Punjab

Topic: Pellet Extrusion based Additive Manufacturing: Research Scope, Challenges and Case Studies

Summary:

- Introduction of AM process, process chain of AM, techniques.
- Fused filament fabrication (FFF): Intro and challenges.
- Direct Pellet Printing, Advantages, possible procedure.
- Case study related to direct pellet printing, challenges, development of customized software module, flexible part fabrication using pellets.

- Ethylene Vinyl Acetate (EVA) material was taken.
- Elastomeric material, which is very flexible in nature.
- Initial results confirmed the feasibility of EVA material.

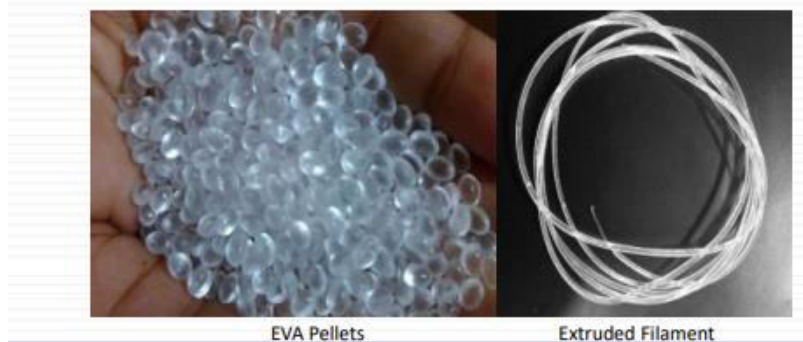

- Case study on flexible electrically conductive composite fabrication.
- Preparation of EVA/Graphite composites

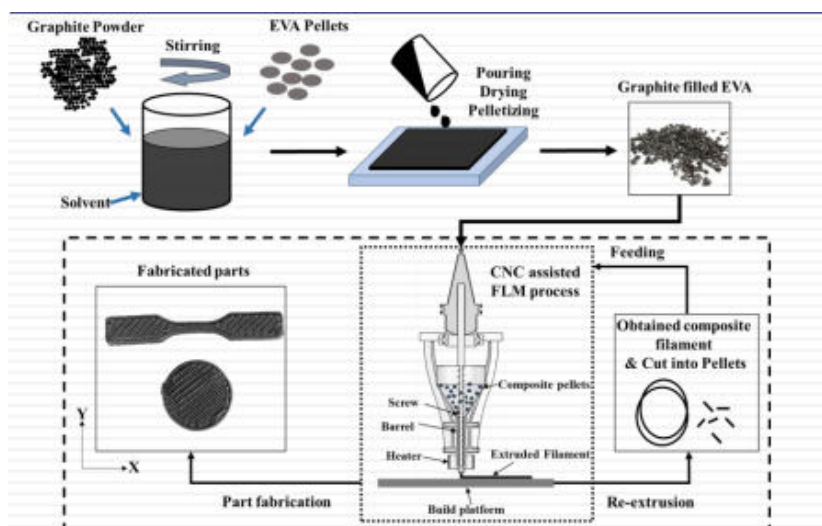

- Calculating electrical and mechanical characteristic of above manufactured material.
- Case Study – Hybrid Direct Pellet printing and machining system.

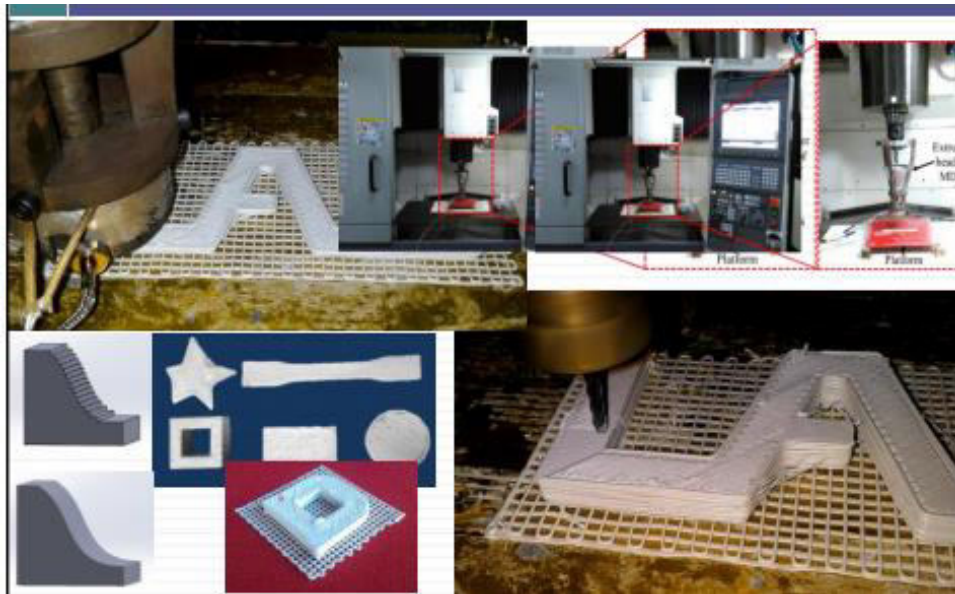

- They developed software for hybrid system
- Discussed future scope of direct pellet printing is given below:

- Considering recent progress, there is lot of scope for further development of direct pellet printing
- The combined efforts of the materials scientists and manufacturing experts are needed
- New compatible materials and their applications are to be explored, which are still challenging today.
- Development of potential printing strategies to develop additive manufactured parts which can compete with their traditional moulding counterparts remains a highly challenging task, which influence applications of these materials.
- 3D printing capabilities would be the driving force for future scope of development of novel compatible materials and to explore their potential applications.

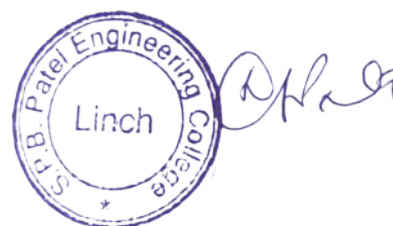

Date: 06.08.2021

Day: Friday

Time: 9.30 am-11.00am

Speaker: Mr. S. Saravana Prabhu Art of Living

Topic: Health is Wealth- One treatment for all Diseases

Summary:

- Discussed some common health problems, their causes, some meditation, some examples of patients getting recovered.

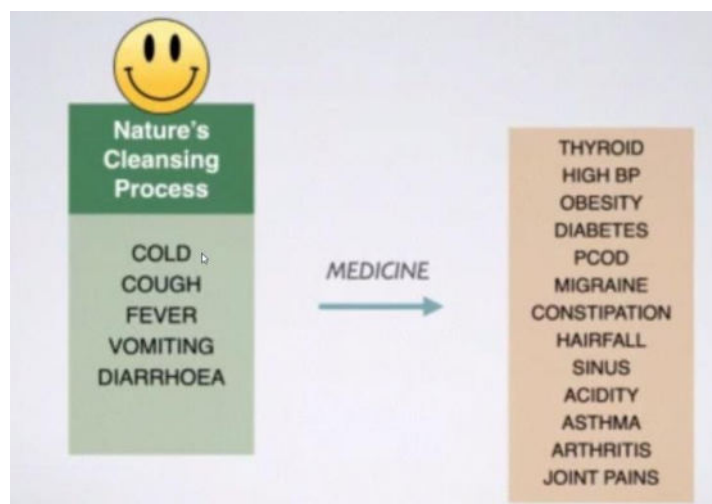
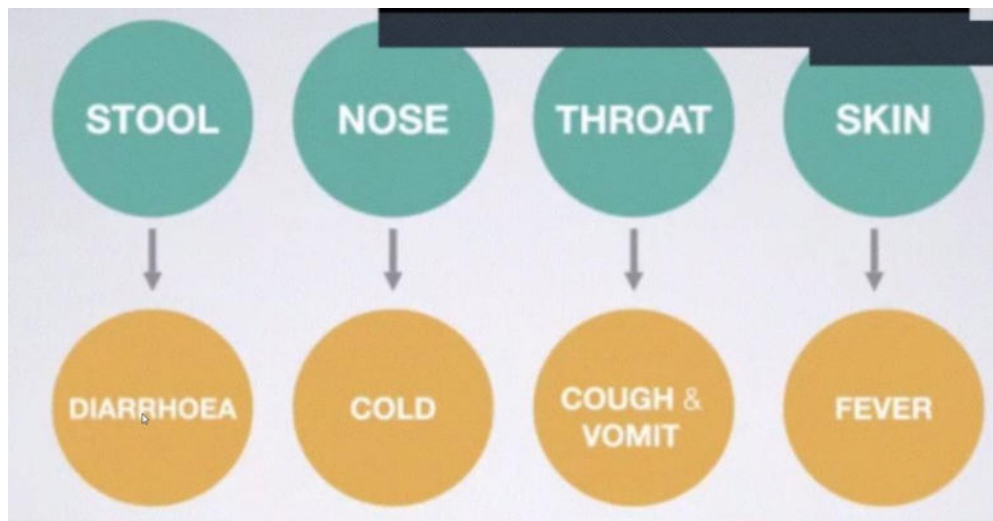

- We don't give enough time to our body for digesting food. We keep on eating one after another so it is the reason for lot of health issues. Wrong food combination, incomplete sleep, our lifestyle, food habits, etc. are causes of several problems.
- They were organizing a complete workshop in weekends on chargeable basis for further in depth discussion and their remedies.

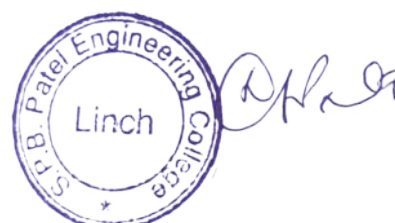

Date: 06.08.2021

Day: Friday

Time: 11.30am -1.00 pm

Speaker: Dr.Prakash Eswaran Associate Professor, Department of Automobile Engineering, Bannari Amman Institute of Technology, Sathyamangalam.

Topic: Do It Yourself 3D Printers and Research scopes

Summary:

- Discussed global market demand in upcoming days.
- Introduction about RepRap Machines, their components.
- Market holders:

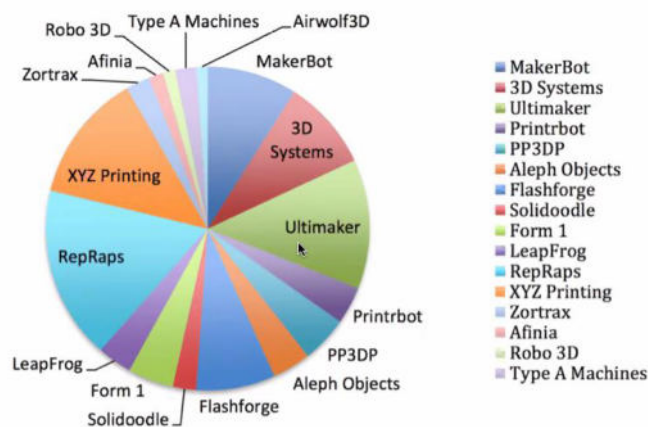

- Cura
- Repetier
- Slic3r
- Simplify3D
- Craftware
- Netfabb Standard
- OctoPrint

- Slicer software----->
- Choco bot – a chocolate 3D printer: methodology, design, specifications.
- ***For every 1kg reduction in weight, airlines save about \$35000 in fuel costs spanning the lifetime of an aircraft.***
- Future technology is 4D printing which is under development.

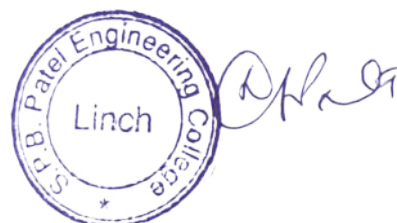

Date: 06.08.2021

Day: Friday

Time: 2.00pm -3.30 pm

Speaker: Dr. Narendra Kumar Assistant Professor Industrial and Production Engineering Department, Dr. B.R. Ambedkar National Institute of Technology, Grand Trunk Road, Bye pass, Jalandhar, Punjab

Topic: Polymer Composite Processing in Additive Manufacturing

Summary:

- FFF, its challenges and materials
- New/composite material development. Fibers and nano-composites are added into the polymer matrix
- Manufacture of polymer composite filament- by melting, using solvent etc.
- Challenges in Compounding methods
- Filament preparation with screw extruder, with twin screw extruder, and their challenges,
- Use of DSC – Digital Scanning Calorimeter to measure difference in heat flow.
- List of commercially available 3D printers

Name	Technology	Materials
Anisoprint	Patented Composite Fiber Coextrusion (CFC) technology	Continuous fibers to a base thermoplastic such as PLA, ABS, PETG, nylon, etc.
Arevo	Laser-based method for printing with carbon fibres.	carbon fibre
Continuous Composites	Continuous dry fiber that is impregnated with a fast curing thermosetting resin	Fiber
CEAD	Continuous Fibre Additive Manufacturing (CFAM)	Different thermoplastic materials combined with both short and continuous glass or carbon fibers.
Desktop Metal	Automated Fiber Placement (AFP)	Nylon (PA6) or HPPs such as PEEK and PEKK loaded with carbon fiber.
EnvisionTec	Selective Lamination Composite Object Manufacturing (SLCOM)	PEEK, PEI, PP, PE (reinforced with carbon fiber, fiberglass, aramid fiber, etc.)
Impossible Objects	composite-based additive manufacturing (CBAM)	carbon fiber and fiberglass paired with Nylon and PEEK
Markforged	continuous filament fabrication (CFF)	4 types of reinforcement, carbon fiber, glass fiber, Kevlar and HSH glass fiber.

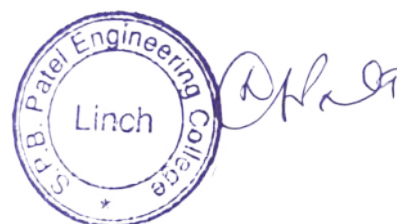

**Yours Sincerely,**

*Kushal*

---

**Prof. Kushal Bhardwaj  
Assistant Professor,  
Mechanical Engineering Department**

---

**Approved By  
Prof. Chitrlekha Nahar  
HoD of Mechanical & Automobile Engineering Department**





S. P. B. PATEL  
ENGINEERING COLLEGE  
SAFFRONY INSTITUTE OF TECHNOLOGY

# CERTIFICATE OF PARTICIPATION

THIS CERTIFICATE IS PROUDLY PRESENTED TO

*Prashant Bhagwan Parashar*

for participating in the **MDP-CERTIFICATE PROGRAM** program during  
**6-8 Sep 2021**, at Saffrony Institute of Technology.

Dr. Narsi Sherasia  
Principal (Degree)



S. P. B. PATEL  
ENGINEERING COLLEGE  
SAFFRONY INSTITUTE OF TECHNOLOGY

# CERTIFICATE OF PARTICIPATION

THIS CERTIFICATE IS PROUDLY PRESENTED TO

*Anurag Rajender Chandnani*

for participating in the **MDP-CERTIFICATE PROGRAM** program during  
**6-8 Sep 2021**, at Saffrony Institute of Technology.

Dr. Narsi Sherasia  
Principal (Degree)



S. P. B. PATEL  
ENGINEERING COLLEGE  
SAFFRONY INSTITUTE OF TECHNOLOGY

# CERTIFICATE OF PARTICIPATION

THIS CERTIFICATE IS PROUDLY PRESENTED TO

*Dr. Narshi Khodabhai Sherasia*

for participating in the **MDP-CERTIFICATE PROGRAM** program during  
**6-8 Sep 2021**, at Saffrony Institute of Technology.

Dr. Narsi Sherasia  
Principal (Degree)



S. P. B. PATEL  
ENGINEERING COLLEGE  
SAFFRONY INSTITUTE OF TECHNOLOGY

# CERTIFICATE OF PARTICIPATION

THIS CERTIFICATE IS PROUDLY PRESENTED TO

*Kunalsinh Ranjitsinh Kathia*

for participating in the **MDP-CERTIFICATE PROGRAM** program during  
**6-8 Sep 2021**, at Saffrony Institute of Technology.

Dr. Narsi Sherasia  
Principal (Degree)



S. P. B. PATEL  
ENGINEERING COLLEGE  
SAFFRONY INSTITUTE OF TECHNOLOGY

# CERTIFICATE OF PARTICIPATION

THIS CERTIFICATE IS PROUDLY PRESENTED TO

*Dr. Pooja Jayeshbhai Mehta*

for participating in the **MDP-CERTIFICATE PROGRAM** program during  
6-8 Sep 2021, at Saffrony Institute of Technology.

Dr. Narsi Sherasia  
Principal (Degree)



S. P. B. PATEL  
ENGINEERING COLLEGE  
SAFFRONY INSTITUTE OF TECHNOLOGY

# CERTIFICATE

## OF PARTICIPATION

THIS CERTIFICATE IS PROUDLY PRESENTED TO

*Jay Paragbhai Parikh*

for participating in the **MDP-CERTIFICATE PROGRAM** program during  
**6-8 Sep 2021**, at Saffrony Institute of Technology.

Dr. Narsi Sherasia  
Principal (Degree)



S. P. B. PATEL  
ENGINEERING COLLEGE  
SAFFRONY INSTITUTE OF TECHNOLOGY

# CERTIFICATE OF PARTICIPATION

THIS CERTIFICATE IS PROUDLY PRESENTED TO

*Avinash Vikrambhai Patel*

for participating in the **MDP-CERTIFICATE PROGRAM** program during  
**6-8 Sep 2021**, at Saffrony Institute of Technology.

Dr. Narsi Sherasia  
Principal (Degree)



S. P. B. PATEL  
ENGINEERING COLLEGE  
SAFFRONY INSTITUTE OF TECHNOLOGY

# CERTIFICATE OF PARTICIPATION

THIS CERTIFICATE IS PROUDLY PRESENTED TO

*Palak Rajeshbhai Godhani*

for participating in the **MDP-CERTIFICATE PROGRAM** program during  
**6-8 Sep 2021**, at Saffrony Institute of Technology.

Dr. Narsi Sherasia  
Principal (Degree)





S. P. B. PATEL  
ENGINEERING COLLEGE  
SAFFRONY INSTITUTE OF TECHNOLOGY

# CERTIFICATE OF PARTICIPATION

THIS CERTIFICATE IS PROUDLY PRESENTED TO

*Yashkumar Pareshbhai Patel*

for participating in the **MDP-CERTIFICATE PROGRAM** program during  
**6-8 Sep 2021**, at Saffrony Institute of Technology.

Dr. Narsi Sherasia  
Principal (Degree)



S. P. B. PATEL  
ENGINEERING COLLEGE  
SAFFRONY INSTITUTE OF TECHNOLOGY

# CERTIFICATE OF PARTICIPATION

THIS CERTIFICATE IS PROUDLY PRESENTED TO

*Dr. Arun Shreeprakash Pandey*

for participating in the **MDP-CERTIFICATE PROGRAM** program during  
**6-8 Sep 2021**, at Saffrony Institute of Technology.

Dr. Narsi Sherasia  
Principal (Degree)



S. P. B. PATEL  
ENGINEERING COLLEGE  
SAFFRONY INSTITUTE OF TECHNOLOGY

# CERTIFICATE OF PARTICIPATION

THIS CERTIFICATE IS PROUDLY PRESENTED TO

*Jagdish Mohanbhai Mevada*

for participating in the **MDP-CERTIFICATE PROGRAM** program during  
**6-8 Sep 2021**, at Saffrony Institute of Technology.

Dr. Narsi Sherasia  
Principal (Degree)



S. P. B. PATEL  
ENGINEERING COLLEGE  
SAFFRONY INSTITUTE OF TECHNOLOGY

# CERTIFICATE OF PARTICIPATION

THIS CERTIFICATE IS PROUDLY PRESENTED TO

*Chintan Tuljashankar Mehta*

for participating in the **MDP-CERTIFICATE PROGRAM** program during  
**6-8 Sep 2021**, at Saffrony Institute of Technology.

Dr. Narsi Sherasia  
Principal (Degree)



S. P. B. PATEL  
ENGINEERING COLLEGE  
SAFFRONY INSTITUTE OF TECHNOLOGY

# CERTIFICATE OF PARTICIPATION

THIS CERTIFICATE IS PROUDLY PRESENTED TO

*Utsav Minesh Shah*

for participating in the **MDP-CERTIFICATE PROGRAM** program during  
**6-8 Sep 2021**, at Saffrony Institute of Technology.

Dr. Narsi Sherasia  
Principal (Degree)



S. P. B. PATEL  
ENGINEERING COLLEGE  
SAFFRONY INSTITUTE OF TECHNOLOGY

# CERTIFICATE

## OF PARTICIPATION

THIS CERTIFICATE IS PROUDLY PRESENTED TO

*Pranoti Chandrashekhar Kale*

for participating in the **MDP-CERTIFICATE PROGRAM** program during  
**6-8 Sep 2021**, at Saffrony Institute of Technology.

Dr. Narsi Sherasia  
Principal (Degree)



S. P. B. PATEL  
ENGINEERING COLLEGE  
SAFFRONY INSTITUTE OF TECHNOLOGY

# CERTIFICATE OF PARTICIPATION

THIS CERTIFICATE IS PROUDLY PRESENTED TO

*Nisarg Vijaykumar Prajapati*

for participating in the **MDP-CERTIFICATE PROGRAM** program during  
**6-8 Sep 2021**, at Saffrony Institute of Technology.

Dr. Narsi Sherasia  
Principal (Degree)



S. P. B. PATEL  
ENGINEERING COLLEGE  
SAFFRONY INSTITUTE OF TECHNOLOGY

# CERTIFICATE OF PARTICIPATION

THIS CERTIFICATE IS PROUDLY PRESENTED TO

*Upasanaben Pingalashibhai Leela*

for participating in the **MDP-CERTIFICATE PROGRAM** program during  
**6-8 Sep 2021**, at Saffrony Institute of Technology.

Dr. Narsi Sherasia  
Principal (Degree)





S. P. B. PATEL  
ENGINEERING COLLEGE  
SAFFRONY INSTITUTE OF TECHNOLOGY

# CERTIFICATE OF PARTICIPATION

THIS CERTIFICATE IS PROUDLY PRESENTED TO  
*Sangitaben Rameshchandra  
Lakhara*

for participating in the **MDP-CERTIFICATE PROGRAM** program during  
**6-8 Sep 2021**, at Saffrony Institute of Technology.

Dr. Narsi Sherasia  
Principal (Degree)



S. P. B. PATEL  
ENGINEERING COLLEGE  
SAFFRONY INSTITUTE OF TECHNOLOGY

# CERTIFICATE OF PARTICIPATION

THIS CERTIFICATE IS PROUDLY PRESENTED TO

*Joseph Sebastian Sibi*

for participating in the **MDP-CERTIFICATE PROGRAM** program during  
**6-8 Sep 2021**, at Saffrony Institute of Technology.

Dr. Narsi Sherasia  
Principal (Degree)



S. P. B. PATEL  
ENGINEERING COLLEGE  
SAFFRONY INSTITUTE OF TECHNOLOGY

# CERTIFICATE OF PARTICIPATION

THIS CERTIFICATE IS PROUDLY PRESENTED TO

*Dixa Nareshbhai Koradia*

for participating in the **MDP-CERTIFICATE PROGRAM** program during  
**6-8 Sep 2021**, at Saffrony Institute of Technology.

Dr. Narsi Sherasia  
Principal (Degree)



S. P. B. PATEL  
ENGINEERING COLLEGE  
SAFFRONY INSTITUTE OF TECHNOLOGY

# CERTIFICATE

## OF PARTICIPATION

THIS CERTIFICATE IS PROUDLY PRESENTED TO

*Meet Manishkumar Jani*

for participating in the **MDP-CERTIFICATE PROGRAM** program during  
**6-8 Sep 2021**, at Saffrony Institute of Technology.

Dr. Narsi Sherasia  
Principal (Degree)



S. P. B. PATEL  
ENGINEERING COLLEGE  
SAFFRONY INSTITUTE OF TECHNOLOGY

# CERTIFICATE

## OF PARTICIPATION

THIS CERTIFICATE IS PROUDLY PRESENTED TO

*Poojan Vipulbhai Shah*

for participating in the **MDP-CERTIFICATE PROGRAM** program during  
**6-8 Sep 2021**, at Saffrony Institute of Technology.

Dr. Narsi Sherasia  
Principal (Degree)



S. P. B. PATEL  
ENGINEERING COLLEGE  
SAFFRONY INSTITUTE OF TECHNOLOGY

# CERTIFICATE OF PARTICIPATION

THIS CERTIFICATE IS PROUDLY PRESENTED TO

*Jaiminkumar Gunvantbhai Suthar*

for participating in the **MDP-CERTIFICATE PROGRAM** program during  
**6-8 Sep 2021**, at Saffrony Institute of Technology.

Dr. Narsi Sherasia  
Principal (Degree)



S. P. B. PATEL  
ENGINEERING COLLEGE  
SAFFRONY INSTITUTE OF TECHNOLOGY

# CERTIFICATE

## OF PARTICIPATION

THIS CERTIFICATE IS PROUDLY PRESENTED TO

*Nishi Prakash Patwa*

for participating in the **MDP-CERTIFICATE PROGRAM** program during  
**6-8 Sep 2021**, at Saffrony Institute of Technology.

Dr. Narsi Sherasia  
Principal (Degree)



S. P. B. PATEL  
ENGINEERING COLLEGE  
SAFFRONY INSTITUTE OF TECHNOLOGY

# CERTIFICATE OF PARTICIPATION

THIS CERTIFICATE IS PROUDLY PRESENTED TO

*Dr. Gaurav Gaurang Joshi*

for participating in the **MDP-CERTIFICATE PROGRAM** program during  
**6-8 Sep 2021**, at Saffrony Institute of Technology.

Dr. Narsi Sherasia  
Principal (Degree)





S. P. B. PATEL  
ENGINEERING COLLEGE  
SAFFRONY INSTITUTE OF TECHNOLOGY

# CERTIFICATE OF PARTICIPATION

THIS CERTIFICATE IS PROUDLY PRESENTED TO

*Chirag Mukeshbhai Korat*

for participating in the **MDP-CERTIFICATE PROGRAM** program during  
**6-8 Sep 2021**, at Saffrony Institute of Technology.

Dr. Narsi Sherasia  
Principal (Degree)



S. P. B. PATEL  
ENGINEERING COLLEGE  
SAFFRONY INSTITUTE OF TECHNOLOGY

# CERTIFICATE

## OF PARTICIPATION

THIS CERTIFICATE IS PROUDLY PRESENTED TO

*Devarshi Dave*

---

for participating in the **MDP-CERTIFICATE PROGRAM** program during  
**6-8 Sep 2021**, at Saffrony Institute of Technology.

---

Dr. Narsi Sherasia  
Principal (Degree)



S. P. B. PATEL  
ENGINEERING COLLEGE  
SAFFRONY INSTITUTE OF TECHNOLOGY

# CERTIFICATE OF PARTICIPATION

THIS CERTIFICATE IS PROUDLY PRESENTED TO

*Mansi Devendrabhai Shah*

for participating in the **MDP-CERTIFICATE PROGRAM** program during  
**6-8 Sep 2021**, at Saffrony Institute of Technology.

Dr. Narsi Sherasia  
Principal (Degree)



S. P. B. PATEL  
ENGINEERING COLLEGE  
SAFFRONY INSTITUTE OF TECHNOLOGY

# CERTIFICATE

## OF PARTICIPATION

THIS CERTIFICATE IS PROUDLY PRESENTED TO

*Bhavik Rasikbhai Patel*

for participating in the **MDP-CERTIFICATE PROGRAM** program during  
**6-8 Sep 2021**, at Saffrony Institute of Technology.

Dr. Narsi Sherasia  
Principal (Degree)



S. P. B. PATEL  
ENGINEERING COLLEGE  
SAFFRONY INSTITUTE OF TECHNOLOGY

# CERTIFICATE

## OF PARTICIPATION

THIS CERTIFICATE IS PROUDLY PRESENTED TO

*Sagar Ramjibhai Thummar*

for participating in the **MDP-CERTIFICATE PROGRAM** program during  
**6-8 Sep 2021**, at Saffrony Institute of Technology.

Dr. Narsi Sherasia  
Principal (Degree)



S. P. B. PATEL  
ENGINEERING COLLEGE  
SAFFRONY INSTITUTE OF TECHNOLOGY

# CERTIFICATE OF PARTICIPATION

THIS CERTIFICATE IS PROUDLY PRESENTED TO

*Nishant Makadia*

---

for participating in the **MDP-CERTIFICATE PROGRAM** program during  
**6-8 Sep 2021**, at Saffrony Institute of Technology.

---

Dr. Narsi Sherasia  
Principal (Degree)



S. P. B. PATEL  
ENGINEERING COLLEGE  
SAFFRONY INSTITUTE OF TECHNOLOGY

# CERTIFICATE OF PARTICIPATION

THIS CERTIFICATE IS PROUDLY PRESENTED TO

*Ekta Pran Shanker Joshi*

for participating in the **MDP-CERTIFICATE PROGRAM** program during  
**6-8 Sep 2021**, at Saffrony Institute of Technology.

Dr. Narsi Sherasia  
Principal (Degree)



S. P. B. PATEL  
ENGINEERING COLLEGE  
SAFFRONY INSTITUTE OF TECHNOLOGY

# CERTIFICATE

## OF PARTICIPATION

THIS CERTIFICATE IS PROUDLY PRESENTED TO

*Ravi Prakashbhai Dal*

for participating in the **MDP-CERTIFICATE PROGRAM** program during  
**6-8 Sep 2021**, at Saffrony Institute of Technology.

Dr. Narsi Sherasia  
Principal (Degree)





S. P. B. PATEL  
ENGINEERING COLLEGE  
SAFFRONY INSTITUTE OF TECHNOLOGY

# CERTIFICATE OF PARTICIPATION

THIS CERTIFICATE IS PROUDLY PRESENTED TO

*Tushar Himanshubhai Panchal*

for participating in the **MDP-CERTIFICATE PROGRAM** program during  
**6-8 Sep 2021**, at Saffrony Institute of Technology.

Dr. Narsi Sherasia  
Principal (Degree)



S. P. B. PATEL  
ENGINEERING COLLEGE  
SAFFRONY INSTITUTE OF TECHNOLOGY

# CERTIFICATE

## OF PARTICIPATION

THIS CERTIFICATE IS PROUDLY PRESENTED TO

*Jigneshkumar Vishnubhai Kadia*

for participating in the **MDP-CERTIFICATE PROGRAM** program during  
**6-8 Sep 2021**, at Saffrony Institute of Technology.

Dr. Narsi Sherasia  
Principal (Degree)



S. P. B. PATEL  
ENGINEERING COLLEGE  
SAFFRONY INSTITUTE OF TECHNOLOGY

# CERTIFICATE

## OF PARTICIPATION

THIS CERTIFICATE IS PROUDLY PRESENTED TO

*Nirav Ratilal Joshi*

for participating in the **MDP-CERTIFICATE PROGRAM** program during  
**6-8 Sep 2021**, at Saffrony Institute of Technology.

Dr. Narsi Sherasia  
Principal (Degree)



S. P. B. PATEL  
ENGINEERING COLLEGE  
SAFFRONY INSTITUTE OF TECHNOLOGY

# CERTIFICATE OF PARTICIPATION

THIS CERTIFICATE IS PROUDLY PRESENTED TO  
*Chetankumar Rameshbhai  
Mordiya*

for participating in the **MDP-CERTIFICATE PROGRAM** program during  
**6-8 Sep 2021**, at Saffrony Institute of Technology.

Dr. Narsi Sherasia  
Principal (Degree)



S. P. B. PATEL  
ENGINEERING COLLEGE  
SAFFRONY INSTITUTE OF TECHNOLOGY

# CERTIFICATE

## OF PARTICIPATION

THIS CERTIFICATE IS PROUDLY PRESENTED TO

*Kapil Kantibhai Dayma*

for participating in the **MDP-CERTIFICATE PROGRAM** program during  
**6-8 Sep 2021**, at Saffrony Institute of Technology.

Dr. Narsi Sherasia  
Principal (Degree)



S. P. B. PATEL  
ENGINEERING COLLEGE  
SAFFRONY INSTITUTE OF TECHNOLOGY

# CERTIFICATE

## OF PARTICIPATION

THIS CERTIFICATE IS PROUDLY PRESENTED TO

*Akhil Venkat Patnaik*

for participating in the **MDP-CERTIFICATE PROGRAM** program during  
**6-8 Sep 2021**, at Saffrony Institute of Technology.

Dr. Narsi Sherasia  
Principal (Degree)



S. P. B. PATEL  
ENGINEERING COLLEGE  
SAFFRONY INSTITUTE OF TECHNOLOGY

# CERTIFICATE OF PARTICIPATION

THIS CERTIFICATE IS PROUDLY PRESENTED TO

*Kishan Ajaykumar Vaghela*

for participating in the **MDP-CERTIFICATE PROGRAM** program during  
**6-8 Sep 2021**, at Saffrony Institute of Technology.

Dr. Narsi Sherasia  
Principal (Degree)



S. P. B. PATEL  
ENGINEERING COLLEGE  
SAFFRONY INSTITUTE OF TECHNOLOGY

# CERTIFICATE OF PARTICIPATION

THIS CERTIFICATE IS PROUDLY PRESENTED TO

*Rajkumar Tarachand Rajai*

for participating in the **MDP-CERTIFICATE PROGRAM** program during  
**6-8 Sep 2021**, at Saffrony Institute of Technology.

Dr. Narsi Sherasia  
Principal (Degree)





S. P. B. PATEL  
ENGINEERING COLLEGE  
SAFFRONY INSTITUTE OF TECHNOLOGY

# CERTIFICATE OF PARTICIPATION

THIS CERTIFICATE IS PROUDLY PRESENTED TO

*Jaimin Harshadrav Jani*

for participating in the **MDP-CERTIFICATE PROGRAM** program during  
**6-8 Sep 2021**, at Saffrony Institute of Technology.

Dr. Narsi Sherasia  
Principal (Degree)



**S. P. B. PATEL  
ENGINEERING COLLEGE**  
SAFFRONY INSTITUTE OF TECHNOLOGY CAMPUS

6 to 10 December 2021

**Report on  
Atal FDP  
“Current Field Practices for Energy and Utility  
Systems”**

FDP by Mechanical Engineering Department  
(GEC, Dahod)

**Prepared By:  
Prof. Tausif Shaikh**  
Mechanical Engineering Department

## **Report on Current Field Practices for Energy and Utility Systems**

**Name of Participant:** Prof. Tausif Shaikh (Mechanical Engineering Department)

**Role:** Participant

**Name of Resource Person:** Dr. D B Jani

**Designation and Institute details:** Associate Professor at GEC, Dahod

**Organized by:** Government Engineering College Dahod

**Date:** 6<sup>th</sup> to 10<sup>th</sup> December 2021

**Duration:** 9:45 am to 5:00 pm

**Venue:** Microsoft Team (Online Platform)

**No. of Participants:** 91 (Faculty Members +Research Scholars)

### **Introduction and Objective:**

Government Engineering College, Dahod has organised A One Week Online Faculty Development Programme (FDP) on “Current Field Practices for Energy and Utility Systems”. Sponsored by AICTE Training and Learning (ATAL) Academy, (AICTE), New Delhi.

In today’s changing energy landscape, business leaders recognize that sustainability is fundamental to remain competitive. As the energy industry shifts to a more ecosystem-centric model to combat climate change, investing in sustainable energy sources helps engage business and people to participate in the change. Utilize the latest technologies to ensure your utility is ready for the new energy ecosystem.

Process industries are typically served by utility systems that provides the necessary energy to carry out day-to-day operations. The Energy and Utilities Industry globally covers **electric generation**: transmission, distribution and retailing, transmission, distribution and retailing of natural gas and water services provision. It also supports the power grid and is relied upon as a reliable energy source.

The main aspiration of this FDP was to knowledge up gradation of Faculty Community of Educational Institutes with respect to **Current field Practices in Energy and Utility Systems**. most importantly bringing in the continuity of propagating the idea of education and delivery during the tough times of COVID 19.



### Key Objectives:

- 1) Knowledge of Technologies available and Research Development processes being carried on the recognize the Current Field Practices for Energy and Utility Systems.
- 2) Discuss the current challenges and gaps in recent interventions for Energy and Utility Systems.

### Target Group:

The Target Audience for this programme was Faculties, Researchers, Educators of Universities, Colleges, and Educational Institutes. This may also include research scholars, academicians etc.

### Methodology:

Power point presentations, video films & discussions.

### FDP Learning:

#### Day 1 - December 6, 2021

**Inaugural Session:** The 5-day Online Faculty Development Programme on, “Current Field Practices for Energy and Utility Systems”, jointly organized by GEC Dahod and AICTE Training and Learning (ATAL) Academy, (AICTE), New Delhi, started with flourishing colours on 6th December, 2021 at 9:45AM with its Inaugural Session. The programme had a gathering of 91 Microsoft Team participants (maximum capacity).

Dr. D R Shah, Programme Coordinator, Atal FDP, set the tone of the Programme and officially welcomed the distinguished speakers, delegates, participants in the programme. Dr. D B Jani, Associate Professor, GEC Dahod, co-hosted the Inaugural session.

**Technical Session:** After the Inaugural Session, the Technical Sessions got started with the first talk from Prof. Virendra Kumar Vijay IREDA Chair Professor Centre for Rural Development and Technology, Indian Institute of Technology Delhi. He gave a brief presentation on, "India's energy security - the role of renewable resources and bio-energy". He further elaborated upon India's Energy Scenario and Challenges. He also highlighted the importance of Energy Security in India.

The 2nd Talk of the Day was from Dr. D B Jani, Associate Professor, GEC Dahod, on, "Performance study on desiccant assisted cooling systems". He spoke in details about the traditional air conditioners suffer from performance degradation especially in humid conditions. This is due to fact that the excess moisture level in ventilation air considerably increases latent cooling load of the space to be conditioned. The use of desiccant integrated vapor compression hybrid cooling system can alleviate this problem by controlling the temperature and humidity separately.

The 3rd and Final talk of the day was from Mr. Nishith Desai, M.Tech.(IITB), Ph.D. (IITB), Post-Doctoral Researcher, Technical University of Denmark on, "Design and Optimization of Solar Thermal Power Plants". He detailed about the Concentrating solar power (CSP) plant with parabolic trough collector (PTC) using synthetic or organic oil-based heat transfer fluid is the most established and commercially attractive technology. He also elaborated about extensive energy and economic analysis of PTC based CSP plants, without storage, are reported. Effects of turbine inlet pressure, turbine inlet temperature, design radiation, plant size, and various modifications of Rankine cycle on overall efficiency as well as levelized cost of energy

At the end of every talk, few relevant questions were taken and speakers answered to the audience.

## **Day 2 - December 7, 2021**

**Technical Session:** The first talk from Dina Nath Akela Manager Operations, Combined Cycle Power Plant Reliance Industries Ltd, Hazira. He gave a brief presentation on, " Boiler Performance Monitoring Digital Solution & Tools". He further elaborated upon Digital technologies and digitalisation have touched every bit of life and have enhanced human comfort significantly over time. Large volumes of digital data generation and acquisition, a quantum leap in computation power, reliable high-speed internet, young digital-savvy workforce, industry 4.0 technologies etc., are accelerating the digitalisation in the plants. Digitalisation is making its presence felt in plant engineering and operation too. It benefits the operators in optimised energy and utility consumption, preservation of the operational know-how and practices, improvement in

safety, remote monitoring, maintenance optimisation, emission control and compliance and satisfaction of operation and maintenance (O&M) staff.

The 2nd Talk of the Day was from Mr. Dharmen Tailor Manger Steam Turbine Engineering, Siemens Energy, on, “Current scenario, challenges and solution with Steam turbine”. He spoke in details about Steam turbine rotors bend during operation, but the bearing and supports are designed to keep the static and dynamic forces under control. However, bending can cause impact between stationary and rotating parts often cascading impacts. An operator of many utility-scale steam turbines shares its extensive field experience identifying the root cause of failures as well as successful solutions. Rotor bending that results in premature failure of steam turbine blades and other internal components is one of the most serious problems experienced in power plant operations. The problems often reduce plant availability by limiting generation and increase plant operation and maintenance cost. He also enlightens the participants about Optimized performance and (fuel) efficiency are essential criteria for driving the development of eco-friendly engines. However, consumers expect these criteria to come along with high reliability and low noise levels. Additionally, manufacturers strive to design a pleasant product sound that reflects a company’s brand image. Tuning an engine to meet all requirements has become a complex balancing act.

The 3rd and Final talk of the day was from Mr Shailesh Verma CEO and Founder, Air N Gas Process Technologies, Vatva, Ahmedabad on, “Use of Pressure Swing Adsorption (PSA) Technique for Air Separation and Biogas Purification”. He detailed about the Pressure swing adsorption (PSA) is at the forefront of gas separation technology. Modern PSA systems used in the industry can vary from 2 adsorbent beds separating air, to 16 bed system producing pure hydrogen in excess of 100, 000 Nm<sup>3</sup>/hr. In spite of receiving continuous attention from the system engineering community, rigorous design and control of industrial scale PSA operation remains a challenging task. This is because of the fact that PSA operation is not only highly nonlinear and dynamic but also poses extra challenges due to its unique property of exhibiting only a cyclic steady state (CSS). The absence of a true steady state is attributed to the fact that a PSA system comprises of a network of bed interconnecting valves, whose active status keep changing over time

At the end of every talk, few relevant questions were taken and speakers answered to the audience.

### Day 3 - December 8, 2021

**Technical Session:** The first talk from Bipin Bhalodiya, Dy General Manager- Package Units, Linde Engineering India Pvt Ltd, Vadodara (An EPC Division of Linde Plc, Germany) (Ex GM Essar Projects Mumbai Ex GM Utilities Reliance Industries Jamnagar ). He gave a brief presentation on, " Overview of Utility Package Units". He further elaborated upon Packaged units – also known as cold boxes – are utilised in a wide range of applications for the treatment of cryogenic fluids and gases, including air separation plants, gas separation and liquefaction plants, chemical and petrochemical plants.

The 2nd Talk of the Day was from Dr. Manoj Kumar Gupta, EDAS Head, IPR on, "Use of cryogenic Technology for Air Separation". He spoke in details about Industrial gases such as oxygen (O<sub>2</sub>), nitrogen (N<sub>2</sub>), and argon (Ar) can be regarded as the "blood" of modern industries such as in steelmaking and chemical product industries, which act as the primary users of the products of air separation units (ASUs) in the world. At present, the production of large quantities of high-purity industrial gases still depends mainly on a large-scale cryogenic air separation method. Here, the terminology "large-scale" means that the O<sub>2</sub> production of a single ASU is beyond 60 000 Nm<sup>3</sup>/h. The development of new electric chip manufacturing also increases the demand for ultrapure air products. In addition, country-driven implementation of integrated gasification combined cycle (IGCC), air separation with utilization of cold energy from liquefied natural gas (LNG) and other launched large projects, give ASUs a broader market prospect.

The 3rd and Final talk of the day was from Dr. Nirvesh Mehta, GEC Dahod on, "Cryogenics". He detailed about the introduction of the basics of cryogenics and then enumerated and explained cryogenic properties such as superconductivity and superfluidity that occur only at cryogenic temperatures. Also, the essential techniques to obtain cryogenic temperatures, the methods of production, and storage were discussed. After that, the preliminary introduction of the thermodynamic process utilized in reducing the temperature of gases, and various methods adapted in the liquefaction of gases were discussed. The presentation also focused on the industrial cryogenic plants associated with the liquefaction of nitrogen gas and helium gas using the Stirling cycle and Claude cycle. The presentation covered the techniques of achieving ultra-low temperatures (below liquid helium temperature, 4.2 K) along with a glimpse of various applications of cryogenics.

At the end of every talk, few relevant questions were taken and speakers answered to the audience.

## Day 4 - December 9, 2021

**Technical Session:** The first talk from Hetal Shah, Commercial Head Reliance Naval and Engg Ltd, Mumbai. He gave a brief presentation on, " Setting up of utility scale wind farm and its current scenario". He further elaborated upon India is blessed with immense renewable energy resources in general and wind energy resources in particular. Evaluating the potential of wind energy resources in changing the energy scenario in the country is vital for development of wind turbine installations in near future. About 34605 MW capacity wind power plants are installed so far as up to September 2018. In the wind energy conversion/utilization, India stands on fourth position in the world and development of wind energy in India. He also discussed the challenges and opportunities in the development of wind energy in the country and also different approaches to increase and expand the utilization of wind resources.

The 2nd Talk of the Day was from Dr. D B Jani, Associate Professor, GEC Dahod, on, "Transys Simulation Software". He spoke in details about The TRNSYS is basically the simulation software used mainly **to simulate the behavior of transient systems**. It is mostly used to simulate solar -based heating and cooling systems in building cooling. The TRNSYS gives prediction for the output in dynamic processes modelling such as traffic control and biological analysis.

The 3<sup>rd</sup> talk of the day was from Bhavesh Patel, Director, Vitthalam Consultants, Surat on, "Operation, Maintenance & Energy Conservation in HVAC Systems". He detailed about the When you integrate energy efficiency into your facility's operation and maintenance (O&M) program, you can reduce energy use without significant capital investment. In addition, efficient O&M strategies: Reduce operating costs, Reduce the risk of early equipment failure and unscheduled down time, increase a facility's net operating income (NOI) and Maintain comfort, leading to fewer "hot and cold" complaints to keep expensive building equipment operating efficiently, make sure to tune it up, turn it off, and check it out

The 4th and Final talk of the day was from Dr P V Ramana, Professor, Mechanical Engineering Department, Sardar Vallabhbhai Patel Institute of Technology, Vasad on, "Solar Wind Hybrid Power Generation Technologies". He detailed about the **India's ministry of new and renewable energy released a solar-wind hybrid policy in 2018**. This provides a framework to promote grid-connected hybrid energy through set-ups that would use land and transmission infrastructure optimally and also manage the variability of renewable resources to some extent.

He also elaborated about India has set an ambitious target of reaching 175 GW of installed capacity from Renewable Energy sources by the year 2022, which includes 100 GW of Solar and



60 GW of Wind power capacity. Various policy initiatives have been taken to achieve this target. As of December 2019, the total renewable power installed capacity in the country was almost 86 GW. To meet the day to day increasing load demand, conventional energy sources are no longer a viable solution as they are depleting rapidly. Solar, due to its dependence on sunlight, can produce power only during the day mainly between 8 am and 5 pm. Wind, on the other hand, usually is more during late evenings and reaches its peak at night. Due to this complementary intermittent nature of wind and solar, power production can be leveled out throughout the day with a Solar-Wind Hybrid. With a hybrid, reliability of the grid is improved by ensuring peak power requirements are met.

At the end of every talk, few relevant questions were taken and speakers answered to the audience.

### **Day 5 - December 10, 2021**

**Technical Session:** First talk from Prof. P.K. Brahmhatt, In-charge Principal, Government Engineering College Dahod. He gave a brief presentation on, " Stress management & Yoga". He further elaborated upon Today's life, stress has become as a part and parcel of life. Its constant presence for long duration negatively affects our day-to-day living. So, our stressed life style is become a major reason for health problems and diseases. In today 's fast life Yoga has become all the more important because of our exposure to various stresses and hazards with very little or no time to recuperate from its after – effects. He also talked about how we can manage stress effectively by stretching our body and also by relaxing our body and mind. So, Yoga can play an important role in stress management because yogic practices which help to strengthen and relax the body and the mind.

The 2nd Talk of the Day was from Dr. S.A. Channiwala, CSIR Bhatnagar Fellow and Retd. Prof., SVNIT, Surat, on, "Next generation power plant using sustainable green energy solutions". He spoke in details about Energy demand in the world is nowadays growing further out of limits of installable generation capacity. Therefore, future energy demands should be met and improved efficiently and securely. Energy solutions should be supported by utilizing renewable energy sources. At present, the contribution of renewable energy to the world primary energy is not high to meet the primary energy and electricity supplies. Both developed and developing nations will necessarily continue to rely on fossil fuels in the coming decades. In developing countries, the situation is more inconvenient than that for developed countries. Many developing countries have been apparently trying to restructure their energy sectors. It seems that it is difficult to realize innovations. Cost, market share and policy are the main barriers for the development of renewable

energy. In the strategy plans of many countries, the sustainable development in relation to the parameters such as economic, social and industrial is supported by their energy policies. He also elaborated about Coal based technologies using green energy Solutions: Coal is used extensively as a fuel in most parts of the world. Burning coal produces about 15 billion tonnes of carbon dioxide each year. Attempting to use coal without adding to atmospheric carbon dioxide levels is a major technological challenge. The greatest challenge is bringing the cost of this down sufficiently for 'clean coal' to compete with nuclear power on the basis of near-zero emissions for base-load power. There is typically at least a 20% energy penalty involved in 'clean coal' processes.

All the esteemed speakers answered to various questions put to them as queries by the learned audience, at the end of their respective talks, efficiently and to the satisfaction of everybody. The 5-day programme thus ended very successfully.

**Valedictory Session:**

Dr. D R Shah, the Programme Coordinator initiated the Valedictory Session by informing the gathering that the programme could cover a wide range of subject topics related to Current Field Practices for Energy and Utility Systems. He wished all the delegates and participants a disaster safe future and congratulated once again the entire team of GEC Dahod for this successful collaboration. The programme ended thus successfully, by wishing, each and everybody success, peace and happiness in their lives and times.

**Yours Sincerely,**

---

**Prof. Tausif Shaikh**

**Assistant Professor, Mechanical Engineering Department**

---

**Approved By**  
**Prof. Chitrlekha Nahar**  
**HoD of Mechanical & Automobile Engineering Department**

**Department of Mechanical Engineering, Government Engineering College Dahod**  
**A One Week Online Faculty Development Programme (FDP) on**  
**“Current Field Practices for Energy and Utility Systems”**  
**(Sponsored by AICTE Training and Learning (ATAL) Academy, (AICTE), New Delhi)**  
**6-10December, 2021**

Date	9.45 am to 10 am	10 am to 12 pm	12 pm to 12.45 pm	12.45 pm to 2.45 pm	2.45 pm to 3.00 pm	3.00 pm to 5.00 pm
<b>06-12-2021 (Monday)</b>	<b>Inaugural Function</b>	"India's energy security - the role of renewables resources and bio-energy" Prof. Virendra Kumar Vijay IREDA Chair Professor Centre for Rural Development and Technology, Indian Institute of Technology Delhi	<b>Lunch break</b>	"Indigenous Water desalination technology using different sources for various capacity Reverse Osmosis Brackish and Sea water Plants for potable water solutions" Mr. S.D. Patil Key Research Scientist, CSMCRI, Bhavnagar	<b>Tea break</b>	Design and Optimization of Solar Thermal Power Plants  Nishith Desai, M.Tech.(IITB ), Ph.D.(IITB), Post Doctoral Researcher, Technical University of Denmark
<b>07-12-2021 (Tuesday)</b>	"Boiler Performance Monitoring Digital Solution & Tools"  Dinanath Akela Manager Operations , Combined Cycle Power Plant Reliance Industries Ltd, Hazira		<b>Lunch break</b>	1. "Current scenario, challenges and solution with Steam turbine" 2. "Vibration diagnosis of rotary machine" Mr. Dharmen Tailor Manger Steam turbine Engineering, Siemens Energy	<b>Tea break</b>	"Use of Pressure Swing Adsorption (PSA) Technique for Air Separation and Biogas Purification" Mr Shailesh Verma CEO and Founder, Air N Gas Process Technologies, Vatva, Ahmedabad
<b>08-12-2021 (Wednesday)</b>	"Overview of Utility Package Units" Bipin Bhalodiya , Dy General Manager- Package Units , Linde Engineering India Pvt Ltd, Vadodara (An EPC Division of Linde Plc , Germany ) (Ex GM Essar Projects Mumbai Ex GM Utilities Reliance Industries Jamnagar )		<b>Lunch break</b>	"Performance study on desiccant assisted cooling systems"  Dr. D.B. Jani Government Engineering College, Dahod	<b>Tea break</b>	"Energy Conservation in Gas Turbine Based Combined Cycle Power Plant" Aniruddhasinh A Vaghela , Chief Manager -Mechanical Gujarat Industries Power Company Ltd - Vadodara
<b>09-12-2021 (Thursday)</b>	"Setting up of utility scale wind farm and its current scenario"  Hetal Shah, Commercial Head Reliance Naval and Engg Ltd, Mumbai.		<b>Lunch break</b>	"Operation , Maintenance & Energy Conservation in HVAC Systems"  Bhavesh Patel, Director, Vitthalam Consultants, Surat	<b>Tea break</b>	"Solar Wind Hybrid Power Generation Technologies" Dr P V Ramana , Professor, Mechanical Engineering Department , Sardar Vallabhbhai Patel Institute of Technology, Vasad
<b>10-12-2021 (Friday)</b>	"Stress management & Yoga" Prof. P.K. Brahmhatt, In-charge Principal, Government Engineering College Dahod		<b>Lunch break</b>	"Next generation power plant using sustainable green energy solutions" Dr. S.A. Channiwala CSIR Bhatnagar Fellow and Retd. Prof., SVNIT, Surat	<b>Tea break</b>	<b>Valedictory program</b>

No: ATAL/2021/1637651119



## ALL INDIA COUNCIL FOR TECHNICAL EDUCATION

Nelson Mandela Marg, Vasant Kunj, New Delhi – 110 070

### AICTE Training and Learning (ATAL) Academy

# *Certificate*

This is certified that **Mr. Tausif M Shaikh, Assistant Professor** of **S.P.B Patel Engineering College, Mehsana** participated & completed successfully AICTE Training And Learning (ATAL) Academy **Online Elementary FDP** on "**Current Field Practices for Energy and Utility Systems**" from **06/12/2021** to **10/12/2021** at **Government engineering college Dahod**.

Advisor-I, ATAL Academy  
Mamta Rani Agarwal



Coordinator

## About the programme

The field of Robotics has now gained immense popularity in respect of dealing with problems in different disciplines all over the world. This FDP is designed to provide knowledge on the basics and recent developments in Robotics, applications and its allied research fields. This program is also aimed to provide hands-on experience on development and testing of mobile robots in real time environment. Since next generation industries need engineers with interdisciplinary attitude and experience to meet the future demands, also to explore the potential areas and the significance in the fields of robotics and automation.

## Content

- Humanoid Robotics
- Collaborative Robots
- Robotic Manipulator Analysis
- Robotics Friction Stir Welding
- Neural Network
- Smart Machine Tools
- Industry 4.0 in Engineering Education
- Automation in Manufacturing
- IoT based Condition monitoring System

## Eligibility;

The faculty members of AICTE approved Institutions, Universities, research scholars; participants from Government, Industry(Bureaucrats/Technicians/Industry experts etc.) and professionals from R&D labs.

## Registration;

- No registration fee
- Registration has to be done only through <https://atalacademy.aicte-india.org/>
- Faculty members of Degree/Diploma courses (GoG) have to register through TNA portal also.

## Organizing Committee

### CHIEF PATRON

Dr. B. J. Shah  
Principal, GEC Modasa

### PATRON

Dr. U. V. Shah  
Head of the Department, MED

### COORDINATOR

Dr. B. C. Khatri  
Associate Professor, MED

### CO-COORDINATORS

Prof. M.M.Madhikar, Prof. Samruddhi Patel, Dr. H.R.Prajapati

### COMMITTEE MEMBERS

Prof. P. M. Mistry, Prof. P.K. Gajjar,  
Prof. P.R.Parekh



ATAL-AICTE SPONSORED FACULTY  
DEVELOPMENT PROGRAM ON

## “ROBOTICS AND AUTOMATION”

**20<sup>th</sup> to 24<sup>th</sup> December 2021**

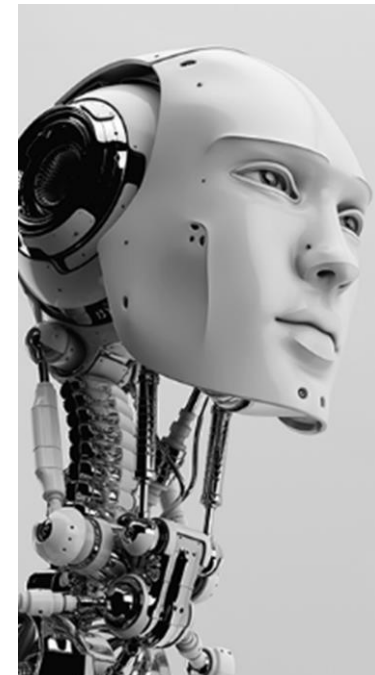

**Organized By;**  
**Department of Mechanical Engineering,**

**GOVERNMENT ENGINEERING COLLEGE,  
MODASA**

## About the Institute

Government Engineering College, Modasa was established in 1984 under the Directorate of Technical Education, Gujarat State, Gandhinagar in North Gujarat region with a view to spread out technical education in the region and hence promote industrial development. The institute was affiliated with Hemchandracharya North Gujarat University (HNGU), Patan from 1984 to 2007. The institute is affiliated to Gujarat Technological University, Ahmedabad from 2008. It is recognized by All India Council for Technical Education (AICTE), New Delhi.

The institute was started with two under graduate courses, with an intake of 60 each. At present it runs seven under graduate courses and two post graduate courses. Each department has well established laboratories, computer centers and well qualified staff.

## About the Department

The department of Mechanical engineering emphasis on all round development of future technocrats. In support of it, many technical seminars, workshops, expert sessions, etc. are organized by department at regular span of interval. Department has well quipped laboratories which provides environment to develop skill amongst students.

## AICTE Training And Learning (ATAL) Academy

All India Council for Technical Education (AICTE) through its newly established AICTE Training And Learning (ATAL) Academy have started unique faculty development programs in various thrust areas of modern technology.

Main objective of ATAL Academy is to plan and help in imparting quality technical education in the country and to support technical institutions in fostering research, innovation and entrepreneurship through training in various emerging areas. Post Covid-19, ATAL Academy has gone totally online.

## Resource Persons

- Dr. Vivek Patel, University West, Sweden
- Dr. Milind Sidhpara, EIT, Australia
- Dr. Ajay Sidhpara, IIT, Kharagpur
- Dr. K. A. Desai, IIT, Jodhpur
- Dr. S S Ohol, COE, Pune
- Dr. RK Sharma, NIT, Hamirpur
- Dr. Akash Pandey, MSU, Vadodara
- Dr. H. P. Patolia, BVM, Anand

## Important Dates

- ✓ Last Date of Registration – 30/11/2021
- ✓ Confirmation of participation (through mail) – 06/12/2021
- ✓ Commencement of FDP – 20/12/2021



## Contact Details

GOVERNMENT ENGINEERING COLLEGE,  
MODASA

Shamlaji Road, Modasa,  
District Aravalli, Gujarat, India. 383315

Email; [hod\\_mechanical@gecmodasa.org](mailto:hod_mechanical@gecmodasa.org)



Government Engineering College, Modasa  
Mechanical Engineering Department  
Tentative Schedule of ATAL FDP

on  
Robotics and Automation

Day	Monday	Tuesday	Wednesday	Thursday	Friday
Date	20/12/2021	21/12/2021	22/12/2021	23/12/2021	24/12/2021
10.30 am to 12.30 pm	Robotics Dr. U. V. Shah GEC Modasa	Robotic Manipulator Analysis and Design using MATLAB Dr. Prashidh Trivedi DY Patil, Pune	Collaborative Robots and Industry 4.0 Dr. Anand Joshi GCET, Anand	Industry 4.0 in Engineering Education Dr. Milind Siddhpura EIT, Australia	Health and Happiness/ Stress Management/ Human values and ethics
1.30 pm to 3.30 pm	Recent Developments in Humanoid Robotics Dr. S S Ohol COE, Pune	Reliability Aspects of Mechtraonic Systems Dr. R. K. Sharma NIT, Hamirpur	Robotics Friction Stir Welding Dr. Vivek Patel University West, Swiden	Smart Machine Tools Dr. K. A. Desai IIT, Jodhpur	Automation in Manufacturing Dr. B. C. Khatri GEC Modasa
3.45 pm to 5:45 pm	Robotics Kinematics & Dynamics Dr. H. P. Patolia BVM, Anand	Neural Network for Robotics and Automation Dr. Akash Pandey MSU, Vadodara	Role of Industry 4.0 in Robotics Dr. A. B. Dhruv GEC Patan	Measurement of 3 Dimensional Micro Machined Features Dr. Ajay Sidhpara IIT, Kharagpur	Online Test and Online feedback

- Schedule is tentative and may be changed due to unavailability of any experts.



**S. P. B. PATEL  
ENGINEERING COLLEGE**

SAFFRONY INSTITUTE OF TECHNOLOGY CAMPUS

January 07, 2022

**Report on  
ATAL FDP  
Robotics**

FDP by GEC, Modasa

**Prepared By:**  
**Prof. Niraj Sorathiya**  
Mechanical Engineering Department



## **Report on ATAL FDP on Robotics**

**Name of Participant:** Prof. Niraj Sorathiya (Mechanical Engineering Department)

**Role:** Participant

**Name of Resource Person:** Dr. Bharat Khatri

**Designation and Institute details:** Associate Professor

**Organized by:** GEC-Modasa

**Date:** 20<sup>th</sup> December 2021

**Duration:** 10:30 am to 5:00 pm

**Venue:** Microsoft Team, Seminar Hall

**No. of Participants:** 186

### **Introduction and Objective:**

The online faculty development program was organised by GEC-Modasa in collaboration with Atal training and learning(ATAL) academy . The FDP was in Robotics as Thrust area. This FDP was organized on a Microsoft team application in online mode. Around 160 participants have been registered for this FDP across pan india. Workshop was organised from december 20,2021 to December 25,2021.The aim of this workshop is to give insights on robot kinematic,neural networks of robots and current trends in robotics.

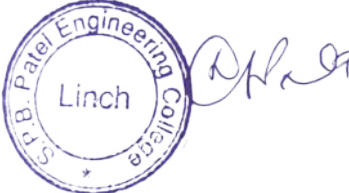

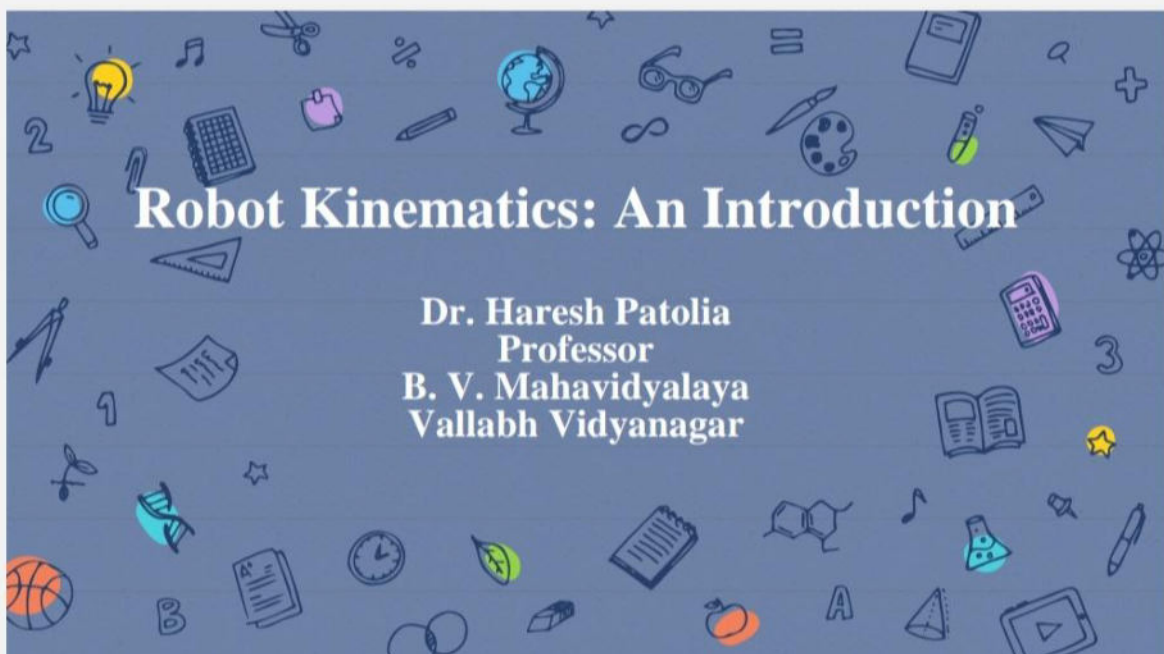
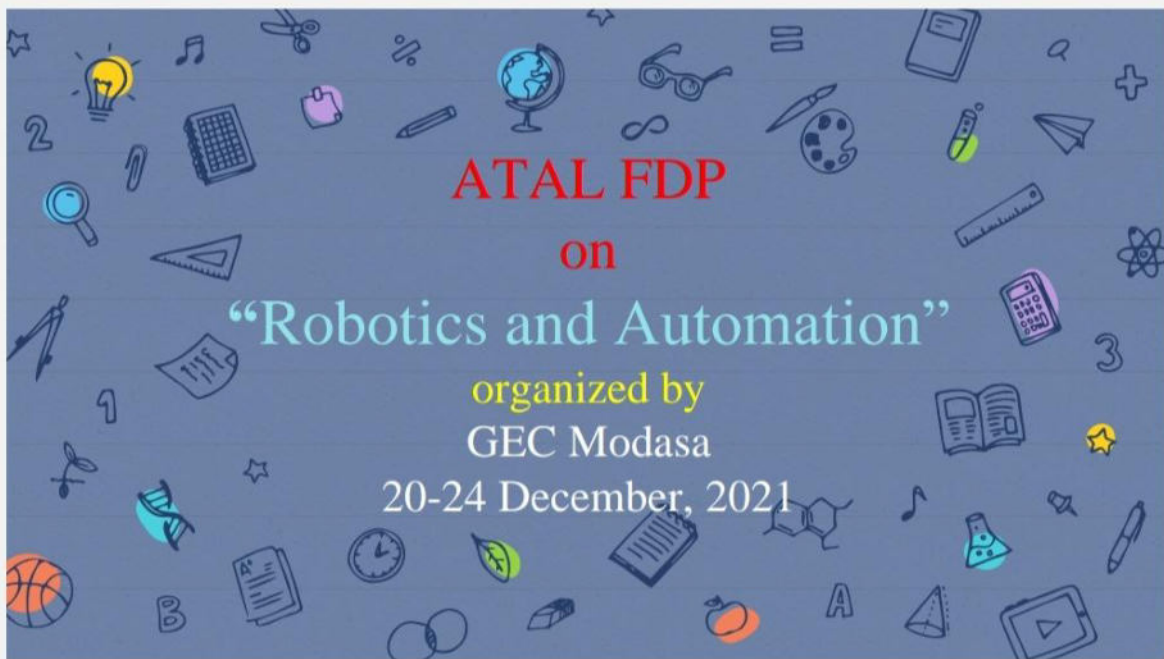

**Workshop details:**

**Day 1 – 20<sup>th</sup> December 2021**

Atal FDP’s inauguration session started at 10.30 PM on the online microsoft team platform. Inauguration was attended by Eminent personalities of AICTE and there was actually 17 FDP was inaugurated. After inauguration, the first session was taken by Dr Bharat Khatri from Government Engineering College, Modasa. This session gives a brief introduction to robotics. History of robotics was nicely explained by Dr Bharat Khatri. Topics like manual machine to fully computer operated robot, its basic components, arm movement, axis designation, wrist movement explained lucidly by the speaker in the first session.



ATAL-FDP AICTE Training and Learning (ATAL) Academy sponsored  
One Week Faculty Development Program on "Robotics & Automation"

# Welcome to all participants

## ATAL FDP on

### Robotics & Automation

(20/12/2021 to 24/12/2021)

Mechanical Engineering Department  
Government Engineering College, Modasa  
Modasa-Gujarat, India  
Website: [www.gecmodasa.ac.in](http://www.gecmodasa.ac.in)

12/20/2021

© Bharat C. Khatri

1



# Robotics

Presented by :  
Prof. Dr. Bharat C. Khatri,  
Associate Professor, MED  
& Coordinator, ATAL-FDP  
Govt. Engg. College,  
Modasa, Gujarat

12/20/2021

© Bharat C. Khatri

2

First session lasted for around 2.30 hrs, then after the second session started at 1.00 PM. Second session was conducted on Robotics kinematics & dynamics.

# ROBOCELL

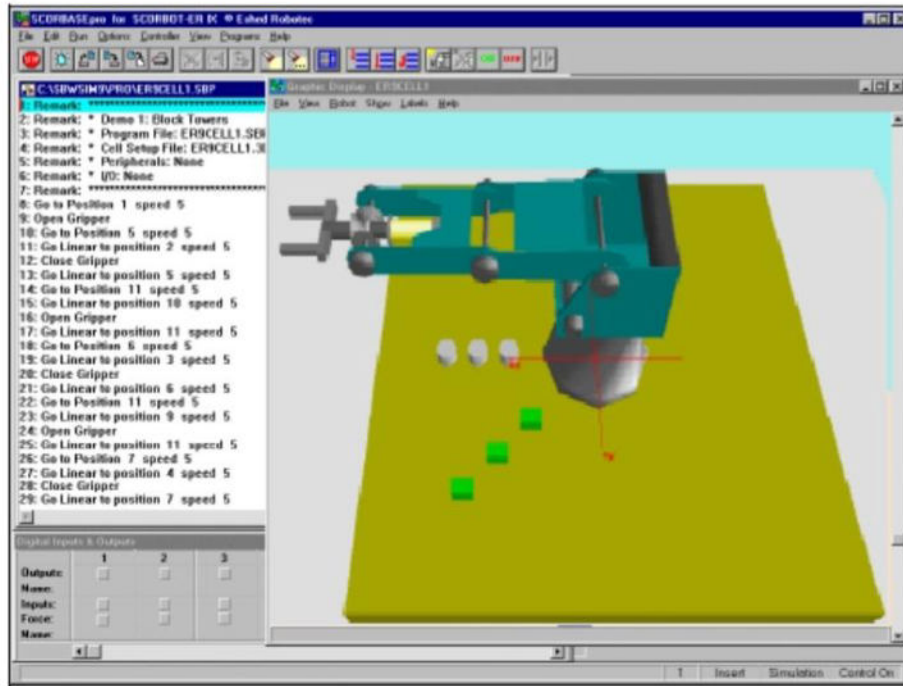

## Day 1 – 21<sup>st</sup> December 2021

On the second day, the session started at 10.30 am sharp. The session was conducted by Dr. Prasad Trivedi from DY patil institute, Pune. Theme of the session was Robotic Manipulator analysis and Design in MATLAB. In this session we got insight on how to program in MATLAB for robotic movements. After a short lunch break the second session started at 1.00 pm. The second session was conducted by Dr. Arshad Noor Sidhdhiquee from Jamia Millia Islamia, New Delhi. The session was on Friction stir additive manufacturing. The main focus is on how robots can be helpful in additive manufacturing.

Third session was on the role of industry 4.0 in Robotics. session was conducted by Dr A.B Dhruv from GEC patan. In this session he give lucid explanation of industry 4.0 and its impact on mechanical engineering.

The overall day was nice and enjoyable. We have learned too much from reputed faculties across India.

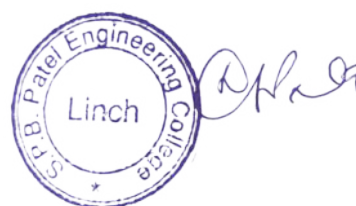

# History of Robotics

## Early Mythology



The notion of **putting machines to work** for us to perform routine tasks on command can be credited to great thinkers like **Aristotle** (384-322 BC).

### Day 3 – 22<sup>nd</sup> December 2021

Day 3 was started with a session on Industry 4.0 with emphasis on Augmented Reality and Virtual Reality. The session was conducted by Dr. Milind Siddhpura. He was from EIT, Australia. In this session we get an idea of augmented reality and virtual reality and their applications. Next session was conducted by Dr. Aarti Sidhdhpura. Expert was from EIT, Australia. Session was on Industry 4.0 with focus on digital twin technology.

Next session was conducted by Dr R. K. Sharma. Dr. Sharma was a faculty member of National Institute of Technology, Hamirpur. The topic of this session was predictive maintenance in industry 4.0. he explained the role of Predictive maintenance in the modern era.

Last session of the day was conducted by Dr. Dipti Upadhyay. The session was on Art of living. It is a non technical session with focus on how one can live healthier. The session was interactive and experts shared their own experiences.

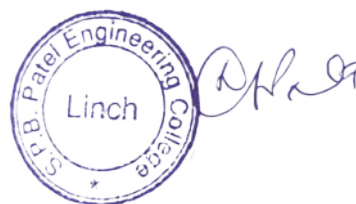

# SCORBASE

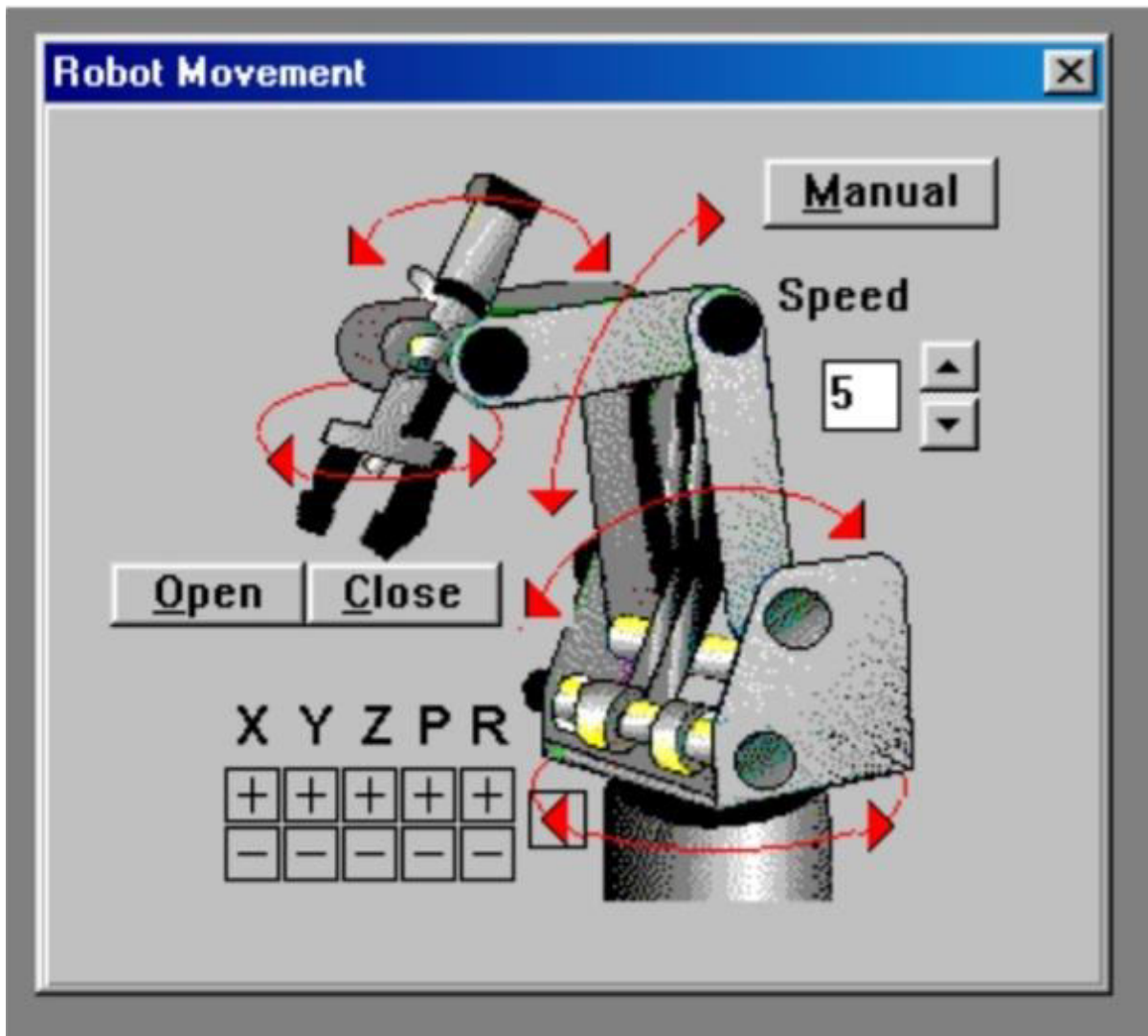

## Day 4 – 23<sup>rd</sup> December 2021

On the fourth day of the Faculty Development Program organized by GEC, Modasa in association with AICTE, the expert of the first session was Dr. Ajay Sidhdhpura. He was an eminent faculty member of Indian Institute of Technology, Kanpur. The theme of the session was surface metrology for robotics application in machining. The session was very interesting. He talked about various devices for the same.

After a short break the next session was conducted by Dr. Bharat Khatri, Who was also co-ordinator of the FDP. Session was on Automation in Manufacturing. It gives insights on CAM. Last session of the day was conducted by Dr. Akash Pandey from The Maharaja Sayajirao University of Baroda. session was on Neural Networks for robots and automation. in this session expert talk about various software for developing neural network in robots

## Day 5 – 24<sup>th</sup> December 2021

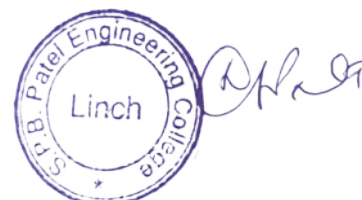

It was the last day of ATAL FDP organised by GEC,Modasa. The first session was conducted by Dr. U.V.Shah from GEC-Modasa. The session was on Robotics Sensor. In this session we get information and knowledge about how different sensors work in robots as well as types of sensors.

The next session was conducted after a short lunch break. The session was conducted by Dr. H. K. raval. He was from SVNIT surat. Session was on Flexible Manufacturing Systems. The session was very interactive. A real world industrial application of the Flexible manufacturing System was shared by experts.

After completion of FDP, Feedback form was rolled out to share feedback. The test was arranged to test the knowledge gained during this FDP. This test was a multiple choice question type having 20 questions. Questions were thought provoking and really knowledge worthy. I scored 18 marks out of 20.

## **Conclusion**

Overall sessions were nice. It gives me an opportunity to learn. As someone truly said that if you stop learning, then you cant be able to teach anymore. Such opportunities provided by the institute are a good initiative. I am thankful to the institute for allowing me to attend this Faculty Development Program.

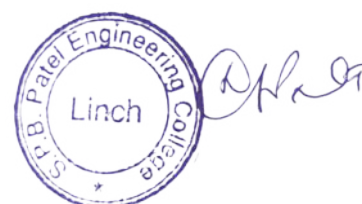

## About the Institute

New Horizon College of Engineering is an Autonomous college affiliated to Visvesvaraya Technological University (VTU), approved by the All India Council for Technical Education (AICTE) & University Grants Commission (UGC). It is accredited by NAAC with 'A' grade & National Board of Accreditation (NBA). It is one of the top Engineering Colleges in India as per NIRF rankings – 2020 and an ISO 9001:2008 certified Institution. New Horizon college of Engineering is in the heart of the IT capital of India, Bengaluru. The college campus is situated in the IT corridor of Bangalore surrounded by MNCs and IT giants such as Intel, Accenture, Capgemini, ARM, Symphony, Wipro, Nokia, JP Morgan and Cisco to name a few. NHCE has Centre of Excellence with reputed industries like Adobe, HPE, VMware, Schneider Electric, SAP, Quest Global and CISCO.

NHCE has a scenic and serene campus that provides an environment which is conducive for personal and intellectual growth. The infrastructure acts as a facilitator for the effective delivery of the curriculum. NHCE boasts of state-of-the-art facilities for its students. The students are given utmost encouragement in their areas of interest by providing hi-tech facilities backed by faculty support. The institute places highest priority on innovative programs of instructions that include both traditional class room theory and professional skills training. There is a strong impetus on overall personality development of the students with emphasis on soft skills. Students are supported through mentoring and counseling systems. The management offers scholarships to meritorious students. At NHCE, from the moment a student walks into the campus, he/she is well guided to know his/her strengths and choose an area of functional specialization. This enables students to concentrate their efforts and energies to gain the competitive edge. NHCE has an unique distinction of achieving 100% admissions in all its courses year after year.

## About the Department

Department of automobile established in the year 2012 with 60 intakes and offers a right mix of curricular, co-curricular and extra-curricular activities. The department of Automobile engineering accredited by the National Board of Accreditation (NBA). This branch deals with the designing, developing, manufacturing, testing, repairing and servicing of automobiles. Students of the department are motivated to attend various technical lectures, programmes, innovative projects and industry oriented program. Employability skills of students are enhanced through various value added programs. Constant interactive relationship is maintained between students and faculty to bring out the knowledge and ideas in various engineering applications. The department strives towards to achieve the goal to strengthen and mould student in professional, ethical, social and environmental dimension. The department has received number of appreciation and grants for student's projects from various government and non-government agencies. The students and faculties of the department actively focus on recent developments such as green energy, Electric and Hybrid vehicle technology, Alternate fuels, and Battery management systems for their innovative projects. Some of the students have taken admissions in top abroad universities to pursue their higher studies. The students of the department are placed in various reputed automobile companies. The department is having MOU with various reputed organizations for students projects, internships, placements and consultancy services. All the Students are actively doing their internship programs in reputed organizations.

## Chief Patron

**Dr. Mohan Manghnani**

Chairman - NHEI, Bengaluru

## Patron

**Dr. Manjunatha**

Principal - NHCE, Bengaluru

## Advisory Committee

**Dr. Amarjeet Singh**

Prof & Dean-Academics, NHCE

**Prof. Gurucharan Singh**

Executive Director, HRD

**Dr. Siddesh G.K**

Head R&D, NHCE

## Program Co-ordinator

**Dr. Shridhar Kurse**

Prof & Head, Department of Automobile Engineering, NHCE

## Co Co-ordinators

**Dr. A. Sujin Jose**

Associate Professor - 8973919442

**Mr. K. A. Jayasheel Kumar**

Sr.Asst.Professor - 9986995105

## Organising Committee

**Ms. Smitha, Sr.Asst.Professor**

**Mr. G.R.Mohan Kumar, Sr.Asst.Professor**

**Mr. A. V. Karthik, Sr.Asst.Professor**

**Mr. Sunil Prashanth Kumar, Sr.Asst.Professor**



**AICTE Training and Learning  
(ATAL)Academy**

**Online Faculty Development Programme**

On

# **“ELECTRIC & HYBRID VEHICLE - DESIGN, INTEGRATION AND CHALLENGES”**

Organized by

**Department of Automobile Engineering**



**27<sup>th</sup> - 31<sup>st</sup> December 2021**

**[www.newhorizonindia.edu](http://www.newhorizonindia.edu)**



## Overview of the AICTE Training and Learning (ATAL) FDP

AICTE Training and Learning (ATAL) FDP in the field of technical education will help participants to gain knowledge on Implementation of Electric Vehicle Technologies and their Opportunity and Challenges On Electric vehicle development. Due to increase in energy demand and the rapid depletion of conventional fossil fuel resources, and environmental pollution the alternative automotive systems has caused great attention today.

## The Objectives of the AICTE Training and Learning (ATAL) FDP

- To effectively understand about the recent developments of Electric & Hybrid vehicle technology
- To understand the design concepts of Electric motors and controllers
- To understand the concepts of Energy storage, Electric motors, Controllers and drive trains
- To develop the design concepts for developing Electric & Hybrid Vehicle technology
- To apply Energy generation technologies to Electric & Hybrid Vehicle
- To overcome the challenges for the development of Electric and Hybrid Vehicle technology
- To develop the knowledge on Autotronics, Sensor Technology applicable for automobiles
- To strengthen the knowledge of faculties and research scholars in the field of Battery Management system
- To provide the platform to faculties and researchers for gathering innovative research ideas and guidance

## Who Can Apply:

This AICTE Training and Learning (ATAL) FDP is open to the faculty members and Research Scholars of AICTE approved colleges, and Industry professionals.

## Resource Persons:

Eminent speakers from IIT, IISc, NIT and Research expert from Industry experience will share their perspective in the fields Electric and Hybrid vehicle technology and the research opportunities.

## Course Contents:

- History of Electric Vehicles
- Need for Electric and hybrid vehicles
- Vehicle Subsystems & Engineering Electric complexities
- Approach to powertrain simulation using Mat lab & Simulink
- Battery Management System
- Power of Optimization for Smart Product development
- Research progress on battery thermal management for Electric Vehicles
- EV Test Equipment
- Electric Vehicles (EV) Design Integration and Challenges: Impacts of BEVs and PHEVs and Research Directions
- Thermal management of traction motors and controllers
- Electric vehicle- Motor characteristics, Controllers, applications
- Concepts of hybrid electric drive train, types and Architecture

## Registration

The participants can download Brochure available on the New Horizon College of Engineering Website (<http://newhorizonindia.edu/nhengineering/automobile-engineering>) <https://atalacademy.aicte-india.org/participant/workshop>  
The number of participants will be limited to 200 persons  
The selected applicants will be intimated by E-mail on or before 20<sup>th</sup> December, 2021.

**Note:** The certificate will be issued to those participants who have attended the program with 80% attendance and have qualified with 60% marks in the test conducted at the end of the program.

## Important Date

Last date for registration: 17<sup>th</sup> December 2021.

## Address for communication

**Dr. Shridhar Kurse,**

Prof & Head,  
Department of Automobile Engineering  
New Horizon College of Engineering  
Marathahalli, Bangalore – 560103

**E.mail: [hod\\_automobile@newhorizonindia.edu](mailto:hod_automobile@newhorizonindia.edu)**

**Mob: 9986688726 | 8973919442 | 9986995105**

**Yours Sincerely,**

---

**Prof. Niraj Sorathiya**  
**Assistant Professor, Mechanical Engineering Department**

---

**Approved By**  
**Prof. Chitrlekha Nahar**  
**HoD of Mechanical & Automobile Engineering Department**



**S. P. B. PATEL  
ENGINEERING COLLEGE**

SAFFRONY INSTITUTE OF TECHNOLOGY CAMPUS

January 28, 2022

Report on

ATAL FDP

**Electric & Hybrid Vehicle- Design, Integration and  
Challenges**

FDP by New Horizon College of Engineering

**Prepared By:**

**Prof. Divyang Patel**

Mechanical Engineering Department

## **Report on ATAL FDP on Electric & Hybrid Vehicles**

**Name of Participant:** Prof. Divyang Patel (Mechanical Engineering Department)

**Role:** Participant

**Name of Resource Person:** Dr. Sujin Jose

**Designation and Institute details:** Associate Professor

**Organized by:** NHCE-Banglore

**Date:** 27<sup>th</sup> -31<sup>th</sup> December 2021

**Duration:** 9:30 am to 3:30 pm

**Venue:** Zoom Link, Online

**No. of Participants:** 89

### **Introduction and Objective:**

The online faculty development program was organised by NHCE-Banglore in collaboration with Atal training and learning(ATAL) academy . The FDP was in the electric & hybrid vehicle field. This FDP was organized on a zoom application in online mode. Around 89 participants have been registered for this FDP across pan india. Workshop was organised from December 27,2021 to December 31,2021.The aim of this workshop is to give insights on electrical vehicles with hybrid systems and also its design, integration & challenges to current situations.

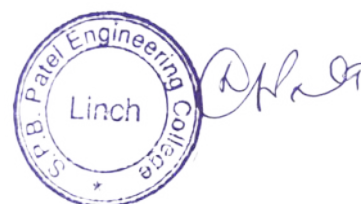

**Day:1 (27<sup>th</sup> DEC 2021)**

**NEW HORIZON COLLEGE OF ENGINEERING**  
DEPARTMENT OF AUTOMOBILE ENGINEERING  
Presents

AICTE TRAINING AND LEARNING (ATAL) ACADEMY SPONSORED  
Five Days Online Faculty Development Program on  
"Electric and Hybrid Vehicle – Design, Integration and challenges"  
27th Dec – 31st Dec 2021  
INAUGURAL SESSION (27th Dec 2021) PROGRAM SCHEDULE

<b>9.30 AM-9.35 AM</b> Welcome Address <b>Dr. Shridhar Kurse,</b> Professor & Head - Automobile Engg NHCE	<b>9.35 AM -9.40 AM</b> Presidential Address <b>Dr. Manjunatha</b> Principal NHCE
<b>9.40 AM -10.00 AM</b> Keynote Address <b>Dr.K.C.Vora,</b> Chief Guest COEP & Former Sr Deputy Director, Automotive Research Association of India Pune	<b>10.00 AM -10.05 AM</b> Vote of thanks <b>Mr.E.A.Jayasheel Kumar,</b> Senior Assistant Professor - AE NHCE

**NEW HORIZON COLLEGE OF ENGINEERING**  
DEPARTMENT OF AUTOMOBILE ENGINEERING  
Presents

AICTE TRAINING AND LEARNING (ATAL) ACADEMY SPONSORED  
Five Days Online Faculty Development Program on  
"Electric and Hybrid Vehicle – Design, Integration and challenges"  
27th Dec – 31st Dec 2021  
DAY 1 - 27 TH DECEMBER

<b>9.30 - 10.05 AM</b> <b>Dr.K.C.Vora</b> Chief guest Emeritus Professor, COEP & Former, Sr Deputy Director, ARAI	<b>10.05 - 11.15 AM</b> <b>Dr. Alla Bhaksh Naikodi</b> Head of EV, Royal Enfield, Chennai.
<b>11.30 - 1 PM</b> <b>Mr.Suraj S D</b> CEO, Decibels Lab	<b>2PM -3.30 PM</b> <b>Mr. Srinidhi C V</b> EV R&D ENGINEER, Decibels Lab

**Session:1 (Dr. Alla Bhaksh Naikodi)**

Atal FDP's inauguration session started at 9:30 AM on the online zoom platform. It was delivered by four different speakers of NHCE's professor. After inauguration, the first session was taken by Dr. Alla Bhaksh Naikodi from royal enfield, chennai. He is the head of EV department.

In the first session, He was presented with a brief introduction about electric vehicles. Also in this session he briefly told about present and future scope of electrical vehicles.

**Prevailing Conditions**

**Problems of the 21<sup>st</sup> Century**

- Economics**
  - Rising oil prices
  - Resource scarcity
  - International politics
- Policies**
  - Emission Standards
  - Limiting CO2 emission
  - International policies
- Society**
  - Increasing traffic
  - Urbanisation
  - Increasing populations
- Environment**
  - Climate change
  - Pollutant emission
  - Global Warming

**Social change, resource depletion & urbanization characterize the future of mobility**

**WHERE DO BIG FOUR EMITTERS STAND**  
% of contribution to global CO2 emissions in 2018

China: 28	US: 15	EU: 9	India: 7
-----------	--------	-------	----------

**Per capita CO2 emissions in 2018 (tonnes)**

India: 1.3	US: 4.5	China: 1.9	EU: 1.8
------------	---------	------------	---------

**KYOTO PROTOCOL**

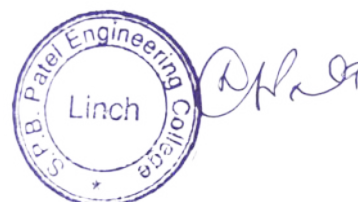

You are viewing Dr K C Vora's screen REC View Options

# Need of the Hour

### Percentage of Net CO2 emission

Source: US Environment Protection Agency

### Proposed Solution? Zero Emission Vehicles

### Rise of Electric Vehicles in 21<sup>st</sup> Century

### 360% RISE IN VEHICLES IN 20 YRS

**VEHICLES AND ROAD SPACE**

Vehicle Type	Roadshare (%)
Two-wheelers	28.4
Private cars	49
Auto/taxis	12.8
Buses	2.2
LCV/trucks	7.6

**TREND SINCE 1998**

Category	Rise (%)
rise in vehicles in city	360%
private cars	340%
two-wheelers	385%

**Passenger Vehicles (3.6 mn)**

**Two Wheelers (21 mn)**

**Commercial Vehicles (0.8 mn)**

**Three Wheelers (0.7 mn)**

You are viewing Dr K C Vora's screen REC View Options

# Global Sales of Electric Vehicles

### EVs as a percentage of total vehicle sales, by country

NORWAY	49.1%
ICELAND	19.1%
SWEDEN	8.0%
NETHERLANDS	6.7%
FINLAND	4.7%
CHINA	4.4%
PORTUGAL	3.4%
SWITZERLAND	3.2%
AUSTRIA	2.5%
U.K.	2.5%
BELGIUM	2.4%
CANADA	2.2%
DENMARK	2.1%
FRANCE	2.1%
U.S.	2.1%

### TOP 3 MARKETS BY TOTAL EV SALES IN 2018

**1,053K**

**361K**

**73K**

**India sold 3600 Electric Cars against 3.6 million cars sold in 2018-19 i.e. 0.1%**

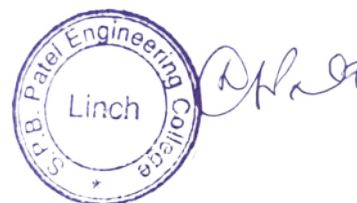

SOURCE: Statista



# India's Goals for Electrification

**Developments:**

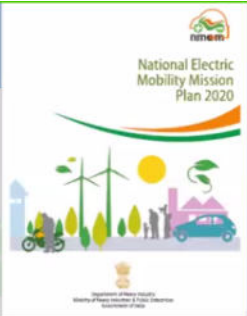
- National Electric Mobility Mission Plan (NEMMP 2020) envisions sale of 6 Million Electric Vehicles.
- FAME India Scheme (Faster Adoption and Manufacturing of (Hybrid) and Electric Vehicles in India) by NITI Aayog incentivises EV ownership by subsidising upfront cost of purchase combined with GST rates slashed.
- EESL (Energy Efficiency Services Ltd) has floated tenders for 4-wheeler Electric Vehicles and procured 10000 vehicles from TATA Motors/Mahindra
- First generation public EV charger standards set.
- Growth in EV in shared mobility sector  
(Ola, Uber, Glyd, Ather Energy, Bajaj, Hero, BluSmart, ElectricFeel, Zbee, Revel, eBikeGo, Gen-Ze, Cow-hov, AFIV, Bird, etc.)





**FAME scheme has 4 focus areas:**

- Technology development
- Demand creation
- Pilot projects
- Charging infrastructure

# Battery Electric Vehicles

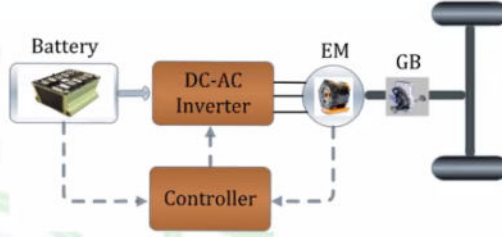
- Vehicles with Motor as the driving unit powered by batteries of appropriate chemistry are BEVS.
- Development of EVs can be traced back to a century ago.
- Lack of battery technology lost the race to the evolving engine technology and abundant fuel resources in 1900s.
- The California Air Resources Board (CARB) launched a mandate for Zero Emission Vehicle (ZEV) for automakers in 1990. This paved a way for the return of the electric cars.





## EVs average range is rising

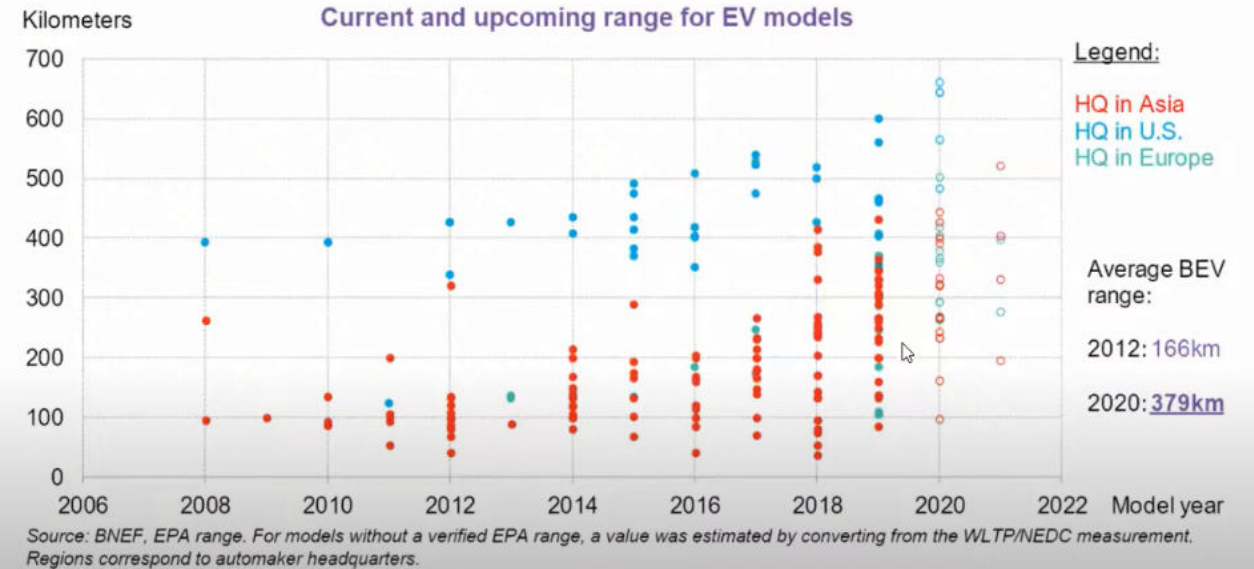

## Charging Eco System - Overview

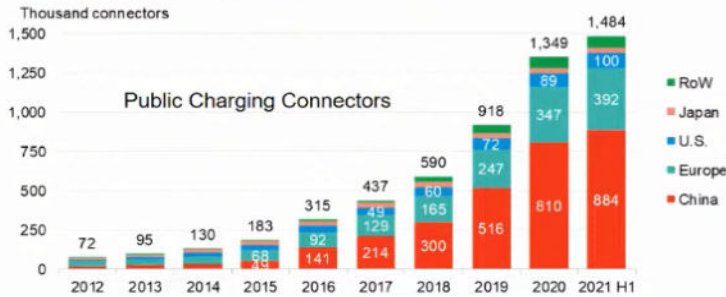

- China investing heavily in installation of Home & Work chargers as Europe and USA dominate that category
- Governments world over are providing significant financial incentives and legal support for charging infrastructure deployment.

- Globally AC Chargers below 43kW constitutes over 70% of all installations
- The current levels of vehicles per charger stands at 7.4 vehicles/charger

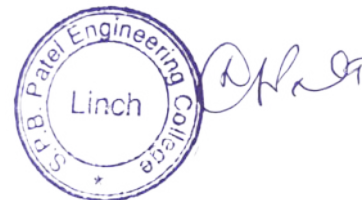



## Day:-1 Session:2 (Mr. Suraj S D)

Justify, EV's are eco-friendly?

the doghouse diaries.com

Copyright of Decibels Lab Pvt. Ltd. lms.decibelslab.com Slide 4

Energy Source for Charging

Credit: ScienceDirect Applied Energy Article

Copyright of Decibels Lab Pvt. Ltd. lms.decibelslab.com Slide 5

Mr. Suraj Sir explained about “ How Ev’s are eco friendly” in detail. Also he gave detailed knowledge about energy source for charging.

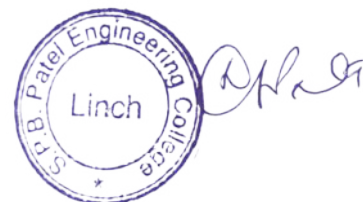

This is how everyone is performing

Annual well-to-wheel car emissions by fuel type (12,000 miles compact/midsize car)

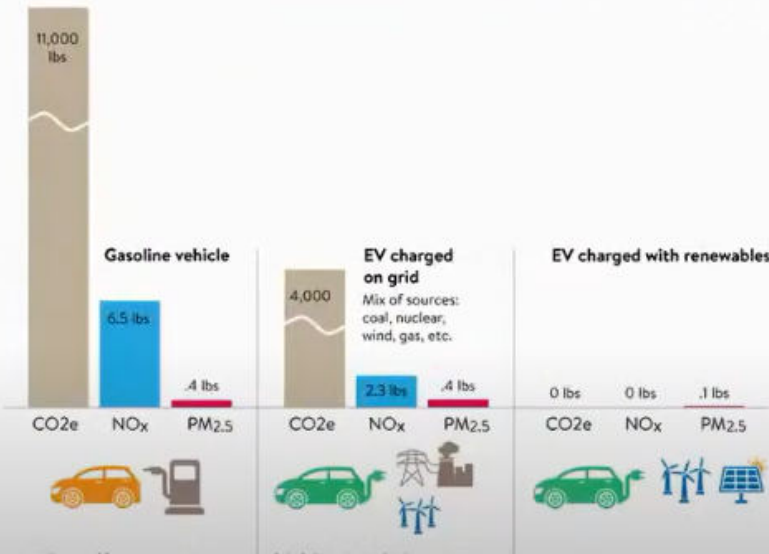

Credit: <https://www.pca.state.mn.us/air/electric-vehicles>

Copyright of Decibels Lab Pvt. Ltd.

[lms.decibelslab.com](https://lms.decibelslab.com)

Slide 7

## Why EV is the focus in transportation segment

U.S. energy consumption by source and sector, 2018 (Quadrillion Btu)

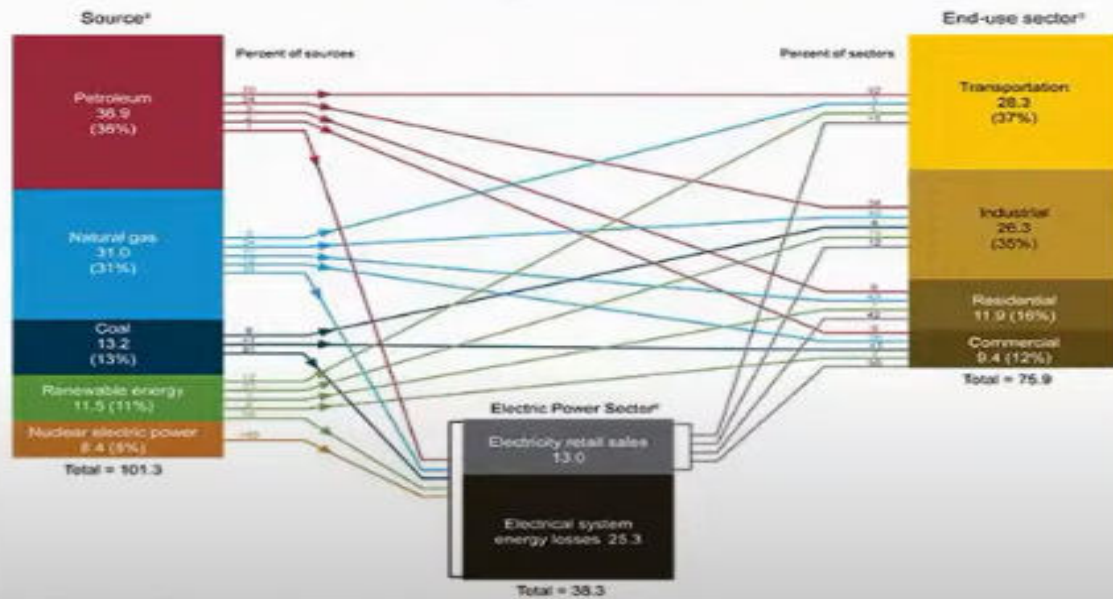

Credit: <https://www.americangeosciences.org>

Copyright of Decibels Lab Pvt. Ltd.

[lms.decibelslab.com](https://lms.decibelslab.com)

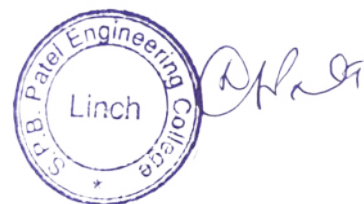

Here after this Sir gave detailed knowledge about analysis of energy for two wheeler segments.

Energy analysis: 2 Wheeler segment comparison - Activa 6G Vs Ather 450 



<https://www.bikewale.com/honda-bikes/activa-6g/>

Range = 50 kmpl  
 Petrol calorific value = 9528 Wh/litre  
**Avg. Energy consumed at wheel (Tank to Wheel)**  
 = Petrol calorific value / Range  
 = 9528 / 50  
 = 190.56 Wh/ km  
 Refinement & transportation efficiency of fuel = 67%  
**Avg. Energy with production & transmission losses (Well to Wheel)**  
 = Avg. Energy at the wheel / Efficiency  
 = 190.56 / .67  
 = **284.4 Wh/ km**



<https://www.atherenergy.com/450>

Range = ~~75~~ 80 km/ full charge  
 Battery Power = 2400 Wh  
**Avg. Energy consumed at wheel (Tank to Wheel) = Battery Power / Range**  
 = 2400/75  
 = 32 Wh / Km  
 Charging and discharging efficiency = 80%  
**Average Energy with battery losses = Average Energy / Efficiency**  
 = 32 / 0.8  
 = 40 Wh / Km  
 Production & transmission efficiency of electricity = 30%  
**Avg. Energy with production & transmission losses (Well to Wheel)**  
 = Avg. Energy with Battery losses / Efficiency  
 = 40/ 0.3  
 = **133.33 Wh/ km**

Copyright of Decibels Lab Pvt. Ltd. ins.decibelslab.com Slide 11

Energy analysis and Comparison - Results and Conclusions 

**Carbon emission comparison**

- CO2 content of Coal is 660 grams of carbon / KWh
- CO2 content of Fuel is 530 grams of carbon per / KWh

Vehicles	Avg. energy consumption (Well To Wheel) Wh/ km	Avg. carbon emission per km g/ km
Activa 6g	284.4	150.73
Ather 450	133.33	87.99
Tata Nexon Petrol variant	836.52	443.35
Tata Nexon EV variant	419.44	276.85

Almost 40 - 100% lower carbon emission per person per vehicle.

He also gave small information about ev's subsystem which was shown below.

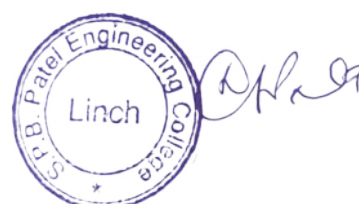

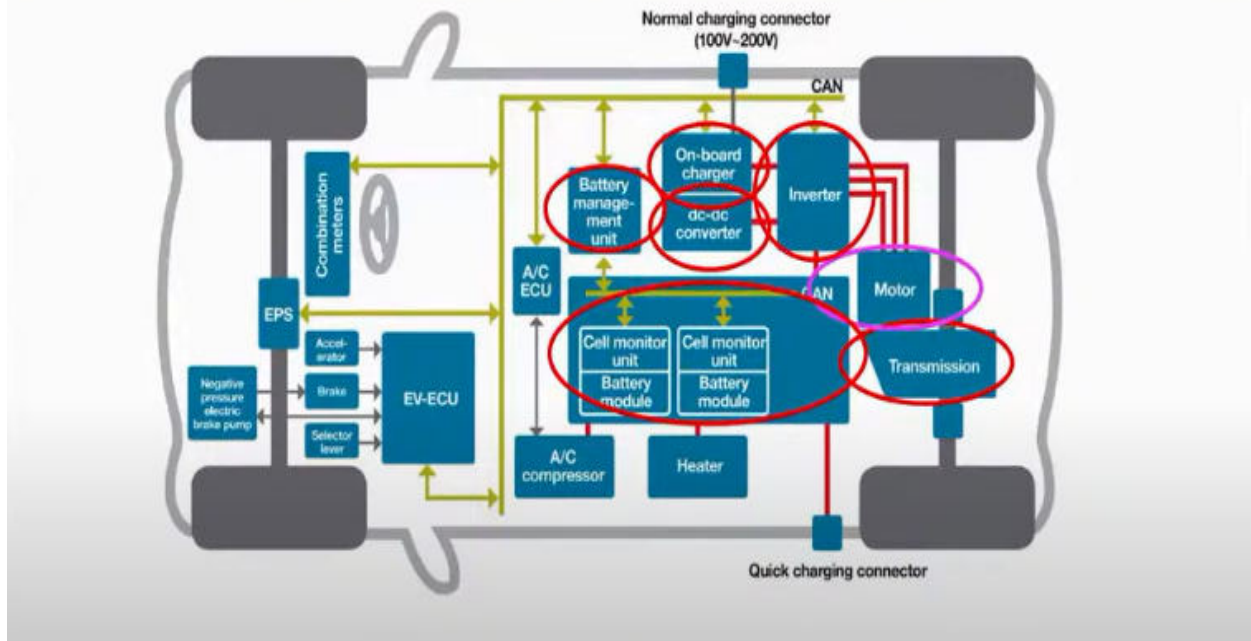

Details for study

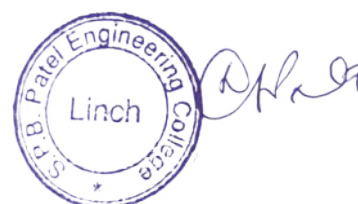
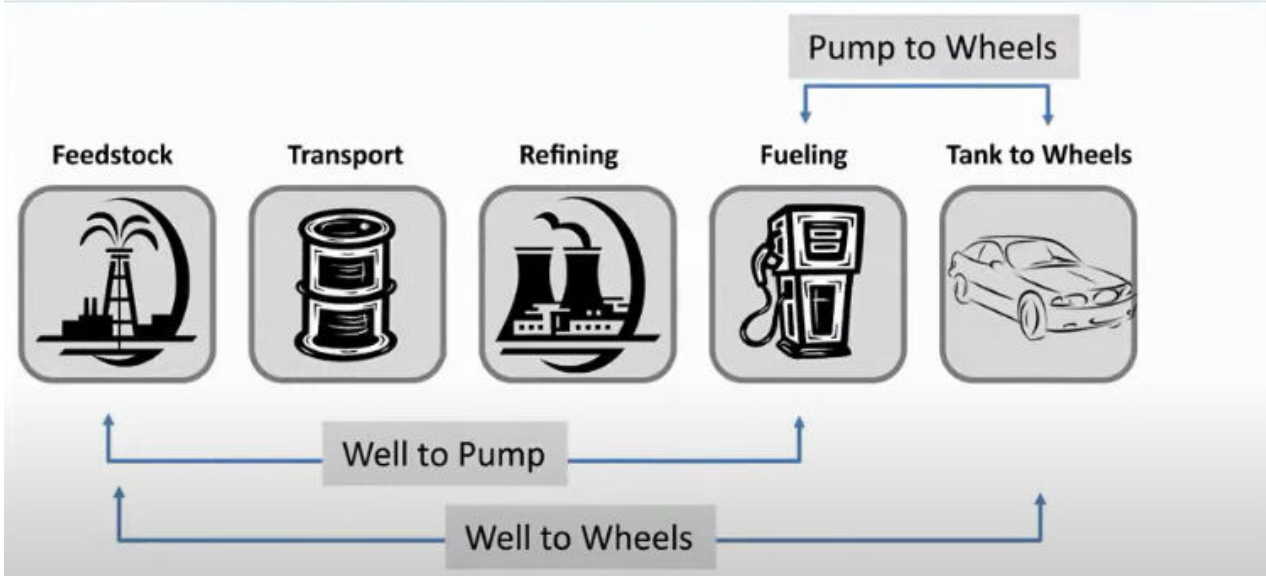

# Day:-1 Session:3 (Mr. Srinidhi C V)

## EV Subsystems – Motor controller

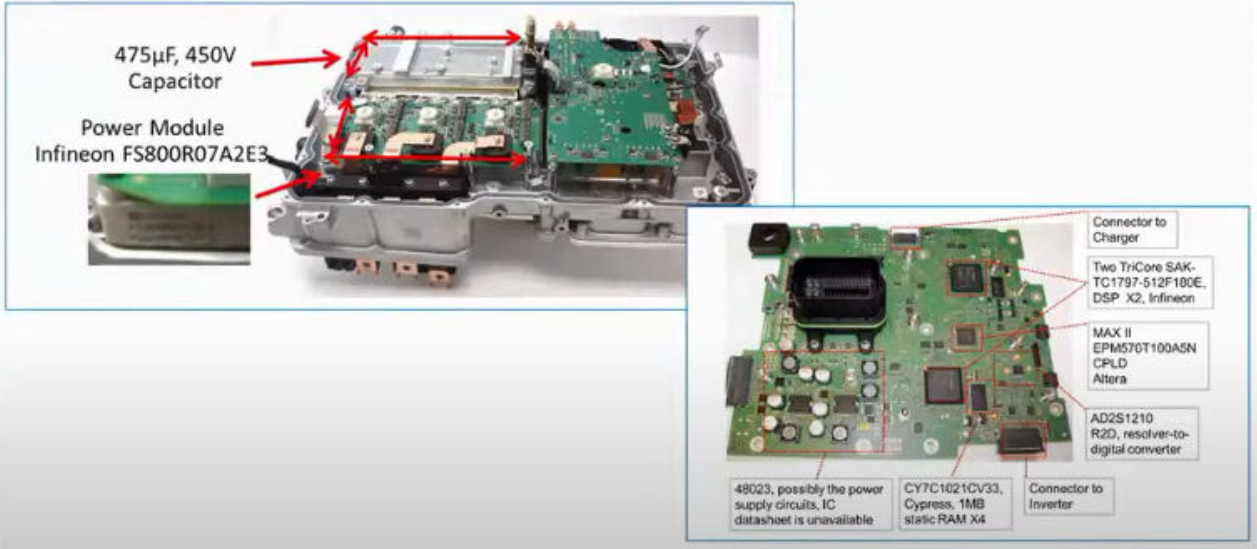

## EV Subsystems – Motors



Mr. Srinidhi sir gave analysis of this subsystem in detail with graphs and all. also explained about the subsystems component which is shown in above figure.

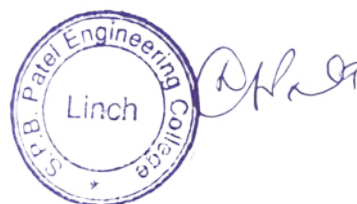

## Day:2 (28<sup>th</sup> DEC 2021)



**NEW HORIZON**  
**COLLEGE OF ENGINEERING**  
DEPARTMENT OF AUTOMOBILE ENGINEERING

AICTE TRAINING AND LEARNING (ATAL) ACADEMY SPONSORED  
Five Days Online Faculty Development Program on  
"Electric and Hybrid Vehicle – Design, Integration and challenges"  
27th Dec – 31st Dec 2021  
DAY 2 - 28TH DECEMBER

**9.30AM - 11.00AM**  
Dr. Manoj Modani,  
Director, Automotive  
Test Systems

**11.30AM - 1.00PM**  
Dr Sushil Ramdasi,  
Deputy Director, PTE,  
ARAI

**2.00PM- 3.30PM**  
Dr Sanjay Patil, GM,  
ARAI Academy

### Day:-2 Session:1 (Dr. Manoj Modani)



**WELCOME**  
TO  
**EV TEST EQUIPMENT**  
BY  
**DR MANOJ MODANI**

**Why EV ?**

Environmental Concerns	Energy Security	Paris Agreement	Thrust on Solar	Depletion of Oil
Fuel Cost Savings	Fueling Flexibility (home/Office/Public Loc)	Regeneration Braking	Simpler Trans./ Low Maint.	Cleaner & Quieter
Power Plant Emission Vs Millions of tailpipes	Motor Efficiency More than 90%	Well to Wheel Efficiency is better	Sustainability	Autonomous/ Connected

Day 2 was about electric vehicle's design, problems of implementation and future scope. Day 2's first session was delivered by Dr. Manoj Modani ( from London). He is the director of Automotive test systems. First of all he taught why electric vehicles are necessary in this current situation. Then after he provided detailed knowledge about standardized process for evs, action took place by government of india for creating market in ev sector and also he provided knowledge about type of certificate for approval of agencies.

# Regulatory Mechanism

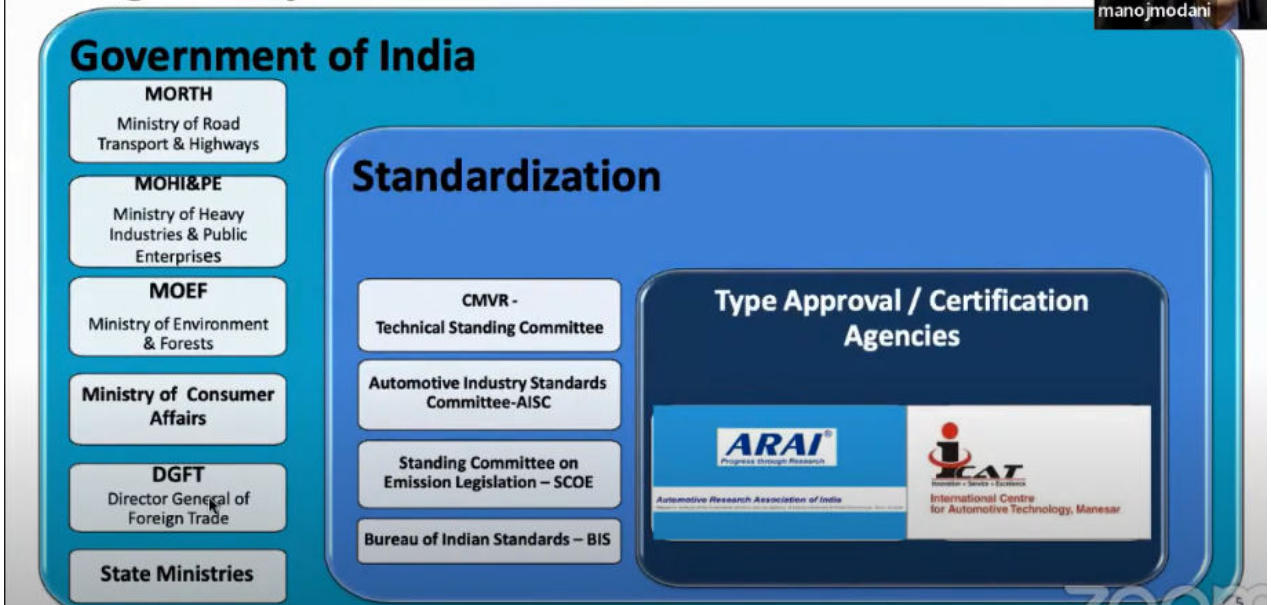
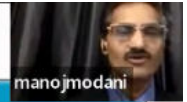

# Categories of Electric Vehicles in India

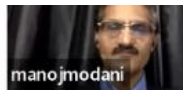

Within private /confined location:  
Hospitals... Air ports...  
Universities...Resorts  
...



<250W Electric 2 W



E-rickshaw/E-Cart



4W Passenger Vehicle (M1/N1 category)



Electric 2 W (L1/L2 category)



E-auto (L5M & L5N category)



Heavy Vehicle (M2/ M3 category)

## Below 250W-EV – No Certification

EVs with following specifications are exempted from CMVR

- 30 minute power of motor  $\leq 250W$
- Max speed  $\leq 25$  km/h

However, to get the exemption certificate they need to be tested for

- **White** reflectors on the front side
- **Red** reflectors on the rear side
- **Brakes**
- Weight of vehicle w/o battery pack must be **less than 60 kg**



## E-rickshaw/E-Cart Vehicle

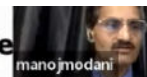

Special EV Category for **First mile** and **Last mile** connectivity under CMVR

- 30 minute power of motor  $\leq 2000W$
- Max speed  $\leq 25$  km/h
- E-rickshaw Seating Capacity= **D+4 Passenger**
- E-Cart Payload=310 Kg
- Dimensions
  - Width= 1Meter
  - Height = 1.8 Meter
  - Length= 2.8 Meter

### E-rickshaw



### E-Cart



# EV Regulations

ma

Indian Standard	Ref. Standard
<b>AIS 038 Rev 1</b> :Requirements for Construction and Functional Safety	ECE R 100
<b>AIS 039 Rev 1</b> : Measurement of Electrical Energy Consumption (Wh/km)	ECE R 101
<b>AIS 040 Rev 1</b> : Method of Measuring the Range (km)	ECE R 101
<b>AIS 041 Rev 1</b> : Measurement of Net Power & Maximum 30 minute power	ECE R 85
<b>AIS 049 Rev 1</b> : CMVR Type Approval for EV	-
<b>AIS 048</b> : Safety Requirements for Traction Batteries	USABC, ISO/IEC Standards

Notified vide S.O.1365(E), dated the 13th December, 2004 and Rev 1  
Notified vide S.O.411(E) Dated 9th February, 2016

## New Battery Safety Standards....

manoj



For L Category Vehicles

**AIS 156** Draft in line with UN R 136.

It covers vehicle electrical safety and REESS safety.

1. Vibration test
2. Thermal shock and cycling test
3. **Mechanical drop test for removable REESS**
4. Mechanical shock
5. Fire resistance
6. External short circuit protection
7. Overcharge protection
8. Over-discharge protection
9. Over-temperature protection



For M & N Category Vehicles

**AIS 038 Rev 2** Draft in line with GTR 20 Phase 1 ( UN R 100 Rev 3)

1. Vibration test
2. Thermal shock and cycling test
3. Mechanical shock
4. **Mechanical integrity**
5. Fire resistance
6. External short circuit protection
7. Overcharge protection
8. Over-discharge protection
9. Over-temperature protection
10. **Over-current protection**
11. **Thermal Propagation Test**

Dr. Manoj sir also taught different parameters for safety means it's standard. He also provided detailed knowledge about EV's regulation in India with different standards.

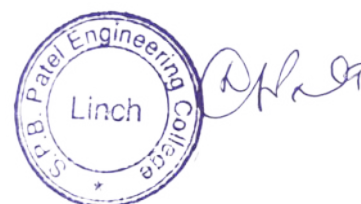



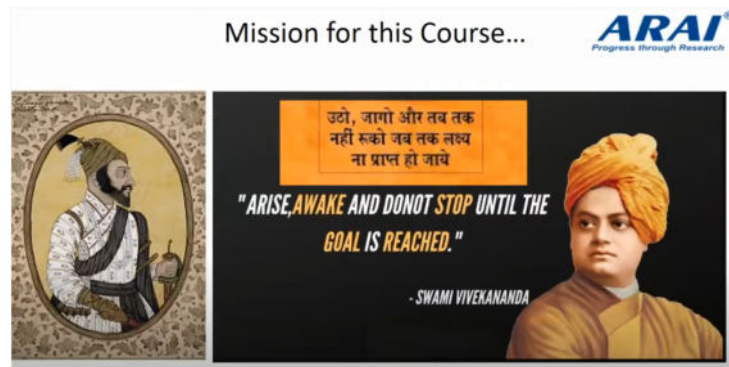

## Day:-2 Session:3 (Dr. Sanjay Patil)



Day 2's session three was delivered by Dr. Sanjay Patil who is the GM of ARAI.

### Electric Vehicle – Path towards Autonomy



**AGENDA / OUTLINE**  
Electric Vehicle  
SAE Levels of Autonomy  
Choice  
Design Proposals  
References

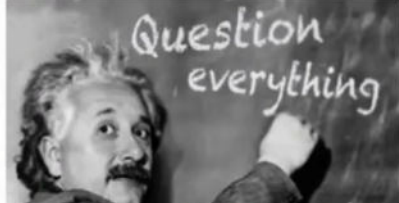

**ELECTRIC & HYBRID VEHICLE – DESIGN, INTEGRATION AND CHALLENGES**  
ATAL Academy, New Horizon CoE, Bengaluru  
27<sup>th</sup> December, 2021 – 31<sup>st</sup> December, 2021  
2:30PM to 3:30PM

The speaker is obliged to the various resources, online and offline. This is a collection of resources from the respective cites and papers. This presentation is for academic consumption and to be used by the audience it was presented to.

Sanjay A Patil



## Outline / Contents

- Electric Vehicle – Block Schematic and Structure
- SAE Levels of Vehicle Autonomy
- Typical Pitfalls / Design Proposals
- Choice
- References

**Day:3 (29<sup>th</sup> DEC 2021)**

**NEW HORIZON**  
**COLLEGE OF ENGINEERING**  
DEPARTMENT OF AUTOMOBILE ENGINEERING  
*Presents*

**AICTE TRAINING AND LEARNING (ATAL) ACADEMY SPONSORED**  
**Five Days Online Faculty Development Program on**  
**"Electric and Hybrid Vehicle – Design, Integration and challenges"**  
27th Dec – 31st Dec 2021  
DAY 3 - 29TH DECEMBER

**9.30 - 11AM**  
**Mr. Ramesha B S**  
Sr. Manager, Academic Initiatives, Altair, Bangalore

**11.30 am - 1 pm**  
**Dr. Dhines Balasubramanian**  
Post Doctoral Research, Khon Kaen University, Thailand

**2 pm- 3.30 pm**  
**Mr. Punit Kongi**  
Assistant Faculty, ARAIAcademy

**Day:-3 Session:1 (Mr. Ramesha B S)**

**ALTAIR** POWER OF OPTIMIZATION FOR SMART PRODUCT DEVELOPMENT  
Ramesha BS– Sr. Manager – Academic Initiatives

He is the senior manager of academic initiatives of Altair, Bangalore.

# Agenda

- Introduction to Altair
- Altair Academic initiatives
- Power of Optimization for Smart product development
- Intro: Electromagnetics & Data Science
- Altair Industry Outreach: A corporate Responsibility



## WAVES OF IMPENDING DISRUPTION - AICTE

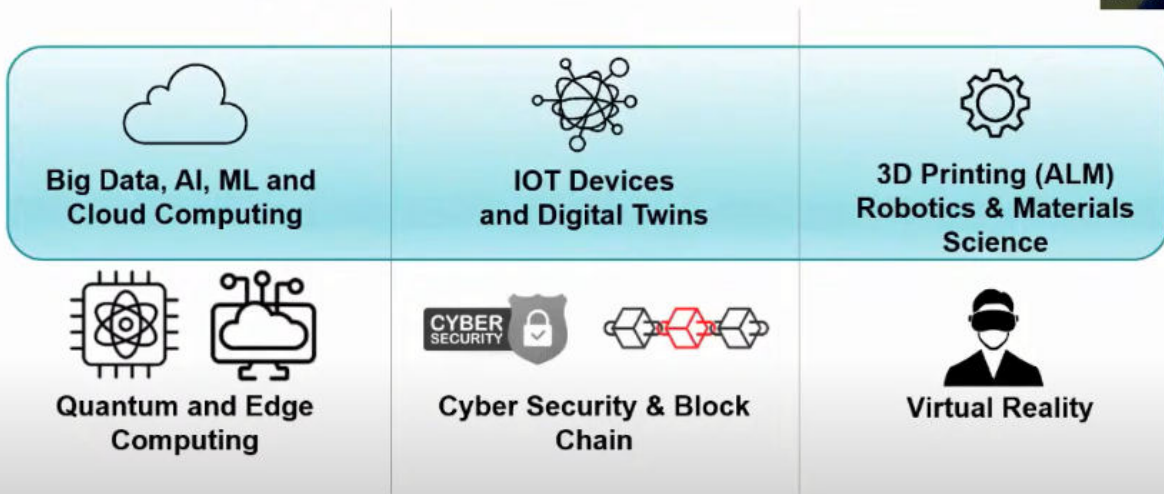
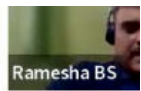

Simulation, Optimization and Machine learning are the dominant means of making Business and Technical decisions

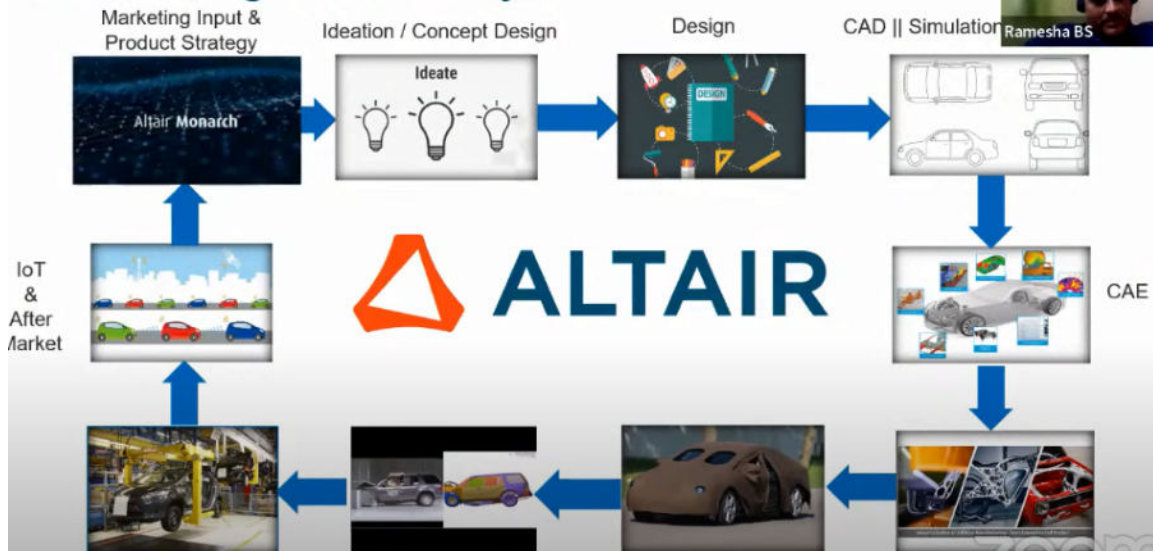

## Understanding Product Life cycle

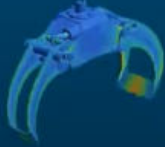

## Altair University Courses: <https://altairuniversity.com/student-guide>

Course/Topic	Altair Solution	Free Learning Collateral					
		eBook	eLearning	Certification	Tutorials	Community	Webinars
<b>DIGITAL MANUFACTURING</b> Emphasis: 3D printing & light-weighting 	Product Page						
	Inspire						
	Inspire Cast						
	Inspire Print3D						
	Inspire Form						
	Inspire Extrude Metal						
	Inspire Extrude Polymer						
<b>STRUCTURAL ANALYSIS</b> Emphasis: FEA & Topology Optimization 	Product Page						
	Inspire						
	SimSolid						
	HyperMesh						
	OptiStruct						
	HyperView						
	SimLab						

## Altair University Courses: <https://altairuniversity.com/student-guide>

Course/Topic	Altair Solution	Free Learning Collateral					
		eBook	eLearning	Certification	Tutorials	Community	Webinars
<b>DIGITAL MANUFACTURING</b> Emphasis: 3D printing & light-weighting 	Product Page						
	Inspire						
	Inspire Cast						
	Inspire Print3D						
	Inspire Form						
	Inspire Extrude Metal						
	Inspire Extrude Polymer						
<b>STRUCTURAL ANALYSIS</b> Emphasis: FEA & Topology Optimization 	Product Page						
	Inspire						
	SimSolid						
	HyperMesh						
	OptiStruct						
	HyperView						
	SimLab						

Sir mostly talked about his company's products and services. Also provided knowledge about courses available at altair. Then after he started simulation about his product and services.

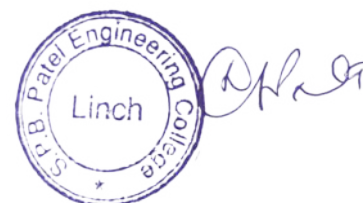

## Concept Design Synthesis: Topology Optimization

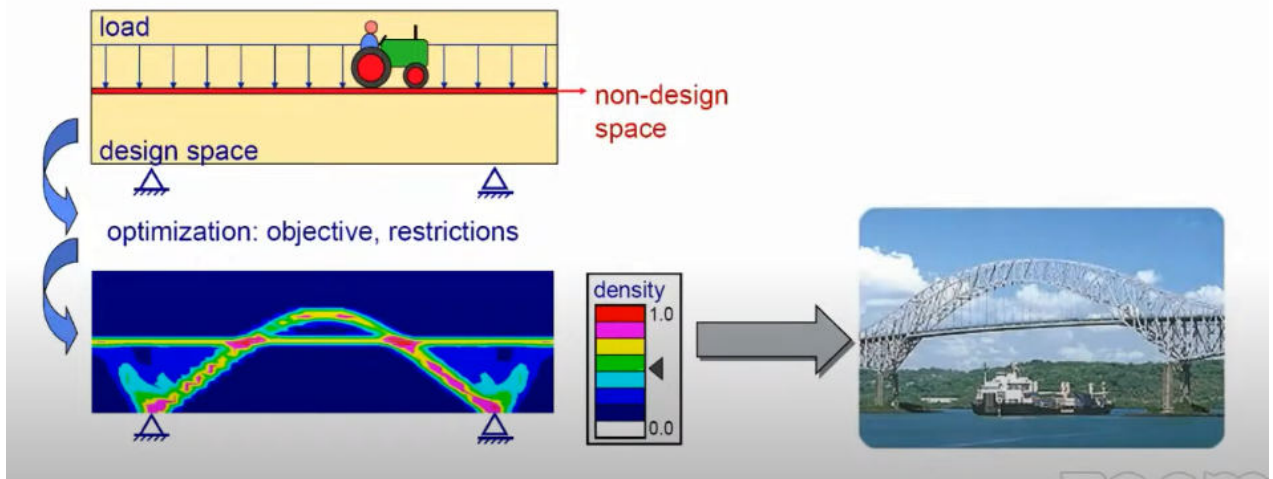

## Concept Design Synthesis - Topology Optimization

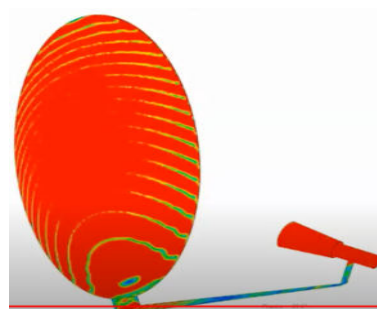
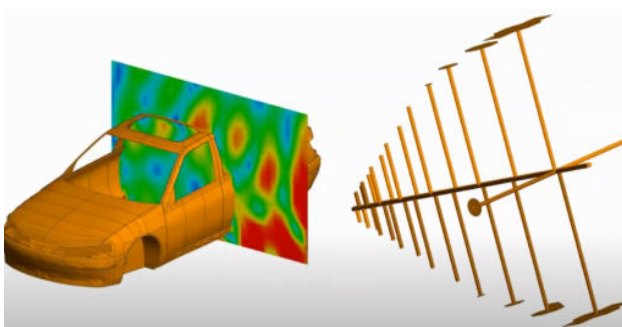
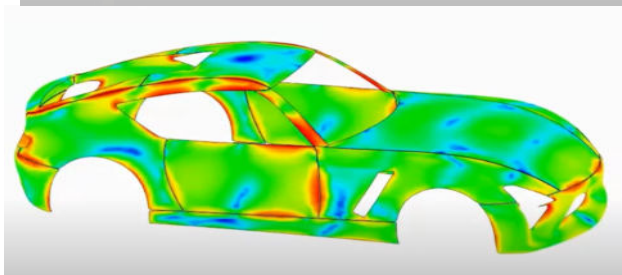
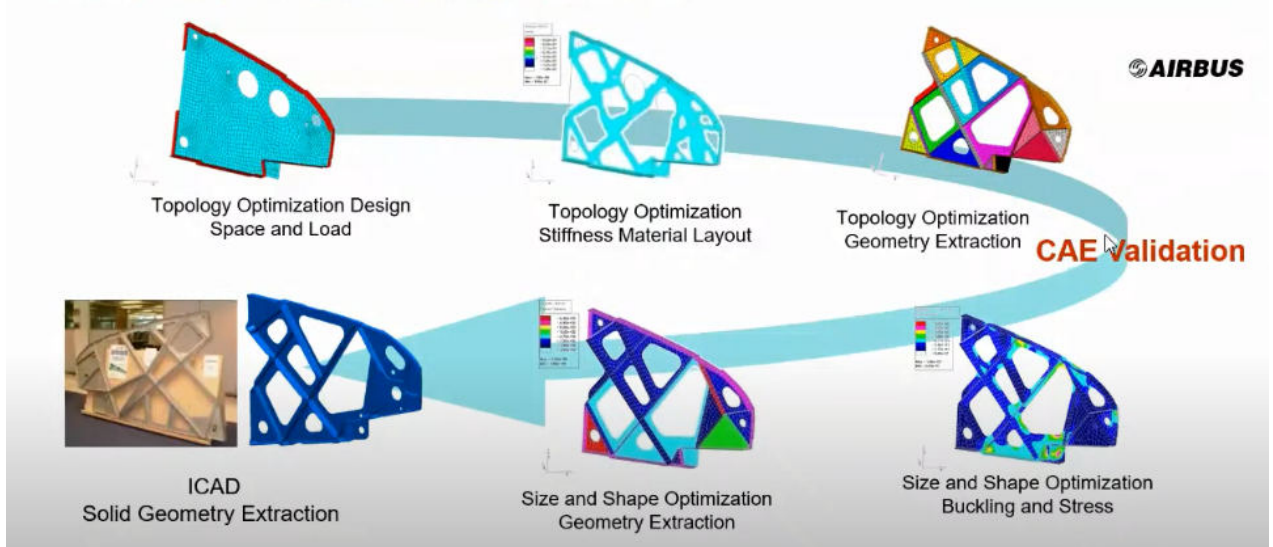

## Day:-3 Session:2 (Dr. Dhines Balasubramanian)

Conducted By



AICTE Sponsored Online FACULTY DEVELOPMENT PROGRAMME On  
"Electric and Hybrid Vehicles - Design, Integration and Challenges"  
from 27<sup>th</sup> to 31<sup>st</sup> December 2021  
Department of Automobile Engineering  
NEW HORIZON COLLEGE OF ENGINEERING,  
Ring Road, Bellandur Post, Bengaluru-560103

In association with



# Recent Research progress on battery thermal management for Electric Vehicles

Assistant Professor (Sr)  
Department of Mechanical Engineering,  
Mepco Schlenk Engineering College,  
Sivakasi, Virudhunagar, Tamil Nadu - 626005

Dr. Dhinesh Balasubramanian,  
Post Doctoral Researcher,  
Mechanical Engineering Division - Faculty of Engineering,  
& Center for Alternative Energy Research and Development

## Agenda

- Introduction
- Recent Research progress on Battery Thermal management System
- Conclusion

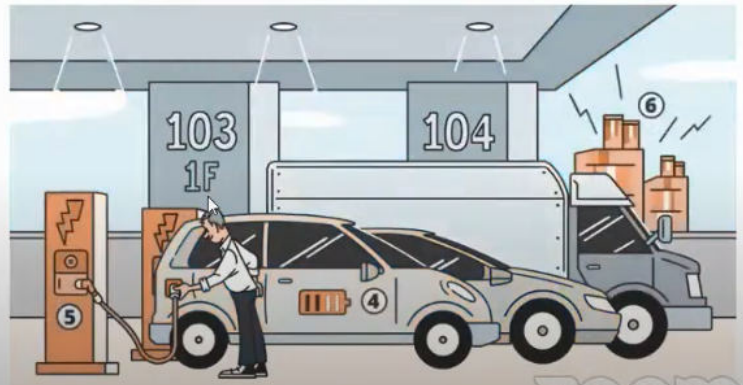

## News !!!



### Zomato commits to 100% adoption of electric vehicles by 2030

2 min read · Updated: 06 Jun 2021, 02:09 PM IST  
HT Auto Desk

• Zomato's founder and CEO Deepinder Goyal has said that his company is already working with a few EV players to facilitate a faster transition towards sustainable delivery solutions.



India is poised to become one of the largest electric mobility markets in the coming decade, with the Government's push to curb pollution and reduce reliance on import dependent fossil

# Road to EV adoption: A review of government targets and policies

## STATES READY WITH THE EV POLICY FRAMEWORK

FAME I (Faster Adoption and Manufacturing of Hybrid and EV) was introduced in 2015 with an outlay of ₹895 crore, and the ongoing FAME II in 2019 with a ₹10,000 crore fund. The two schemes largely offered subsidies for two- and three-wheelers, hybrids, e-cars, e-buses, and for setting up charging infrastructure.

- electric two-wheelers, e-rickshaws, and goods carriers will receive purchase incentives of ₹30,000 ,
- while electric cars would receive incentives ranging between ₹10,000 and ₹150,000.

The government also plans to make public charging facilities accessible every three kilometers in Delhi through the policy



## Definition: Electric Vehicle

- Any vehicle propelled by an **electric drivetrain draining taking power from a rechargeable battery** or from a portable, refillable, electrical energy source (like fuel cell, solar panels, etc.), which is manufactured for use on public road.

### Sustainability:

No tail-pipe emissions ✓

- EVs have no tail-pipe emission
- Reduced air pollution in cities due to CO<sub>2</sub>, SO<sub>x</sub>, NO<sub>x</sub>, particulate matter

Volvo study shows making EVs leads to 70% more emission compared to ICE vehicles

2 min read · Updated: 20 Nov 2021, 04:54 PM IST

HT Auto Desk

- Volvo compared its conventional fossil fuel-powered XC40 with its all-electric C40 and deduced that the production of the latter leads to about 70 per cent more emissions.

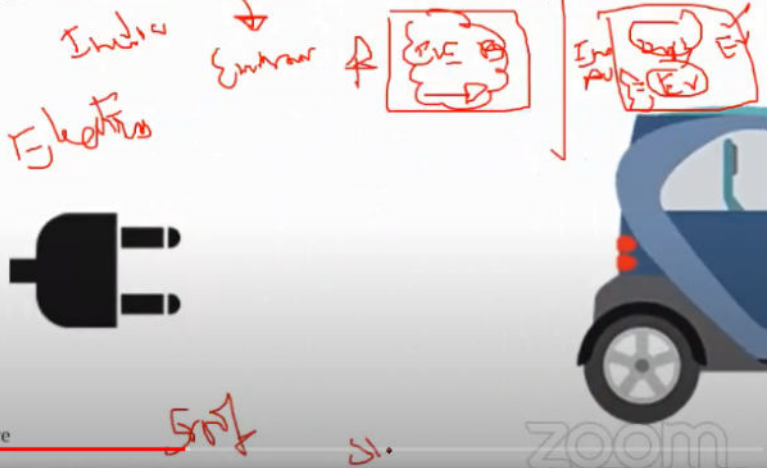

## Battery Issues

- Rechargeable lithium-ion (li-ion) batteries are regarded as the most suitable energy storage device.
- For li-ion batteries' **performance is closely related to temperature**
- Thermal runaway is a phenomenon that can lead to destructive consequences such as **rapid temperature rise, gas generation and even battery explosion** as the process of temperature increase is accelerated
- To reduce the potential risk of thermal runaway, a variety of safety mechanisms have been utilized in li-ion batteries such as
- Safety vents, Thermal fuses, automatic reset devices, shutdown separators, chemical shuttles, coatings and heat-retardant electrolytes and electrodes

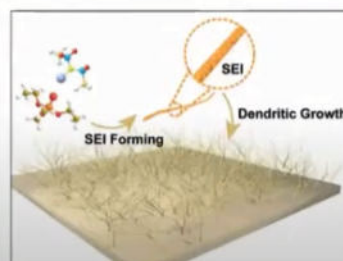
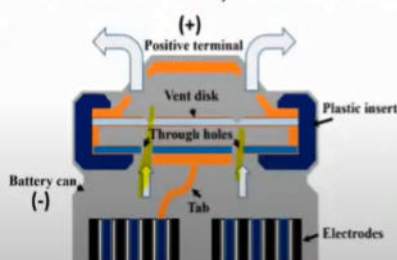

## Day:-3 Session:3 (Mr. Punit Kongi)

He is an assistant faculty at ARAIA academy. He mostly provided knowledge regarding the battery, battery management, simulation and analysis of battery.

### What is a battery management system?

❖ Batteries must be **managed** properly by electronics, software:

- Protect the application user
- Protect the battery pack itself
- Maximize the performance (power and energy) delivered by the battery
- Maximize the service life of the battery pack itself

A BMS comprises purpose-built electronics plus custom designed algorithms (computer methods): it is an embedded system

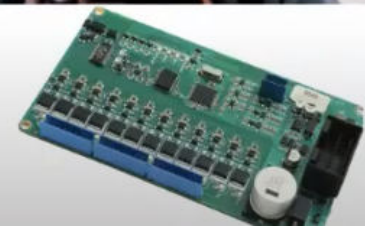

### When do I need a BMS?

- All lithium-ion battery packs require at least a minimal BMS for safety: unmanaged cells can catch fire and explode!
- However, there is a cost associated with battery management, so not all battery-powered applications implement all features
- Your battery is “cheap enough” if you can’t remember the last time you replaced it Larger battery packs represent greater investment, and motivate better battery management.



### Vehicle applications justifying complexity

- Vehicular applications include:
- **Hybrid-electric vehicle (HEV):** Motive power provided by battery plus at least one other source (*e.g.*, gasoline engine), essentially zero all-electric vehicle range
- **Plug-in hybrid-electric vehicle (PHEV):** Larger battery than HEV allows some all-electric range under certain operating conditions
- **Extended-Range Electric Vehicle (E-REV):** Larger battery than PHEV allows some all-electric range under full-load conditions.
- **Electric Vehicle (EV), a.k.a. Battery-Electric Vehicle (BEV):** Battery provides only motive power.



# Introducing important battery terminology

- Cells are the smallest individual electrochemical unit, and deliver a voltage that depends on the cell chemistry
- There are primary (single use) and secondary (rechargeable) cells  
A cell is different from a battery, but many people (including me at times!) use the term “battery” to describe any electrochemical energy source, even if it is a single cell, and this can lead to confusion
- Batteries and battery packs are made up from groups of cells  
These cells can be wired together in series, in parallel, or in some combination of both.
- Sometimes they are packaged in a single physical unit  
For example, automotive 12 V lead-acid batteries comprise six 2 V cells in series
- Other times, the connections are external to the cells
- We use schematic symbols to represent cells and batteries in a circuit diagram.



Cell



Battery



## Energy and power

- A cell stores energy in electrochemical form, which it can later release to do work
- The total energy storage capacity of a cell is roughly its nominal voltage multiplied by its nominal capacity (mWh, Wh, or kWh)
- Example: The nominal energy storage capacity of the example to the right is  $3.7V * 1.9Ah = 7.03Wh$
- The energy release rate is the cell's instantaneous power (mW, W, or kW)



## Cell formats

- Lithium-ion cells are manufactured in different form factors
- Cylindrical cells are... .. cylindrical (round “jelly roll”)
- Prismatic cells are. . . prismatic (flat “jelly roll”)
- Pouch cells are also flat, but comprise stacked plates



Cylindrical cells



Prismatic cells



Pouch cells

# Is lithium going to run out?

- Is there enough lithium for xEVs and other applications? Chart shows relative abundance of elements in earth's crust:

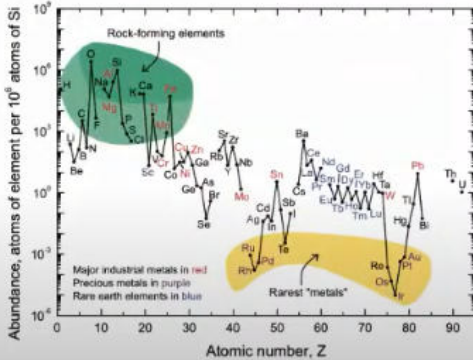

We see that Li is between 20 and 100 times more abundant than Pb and Ni. Still challenging to find in nature since very reactive and not usually found in its free state, but in compounds. Cd and Hg—usage deprecated because of toxicity—1000 times less common than Li.

## So, what does this mean?

- So, lithium content in high-energy cell  $\approx 3\%$  by weight
- xEV cells weigh about  $7 \text{ kg kWh}^{-1}$ : Li content  $\approx 0.2 \text{ kg kWh}^{-1}$
- 200-mile EV needs  $\approx 60 \text{ kWh}$  battery: Li content  $\approx 12 \text{ kg / EV}$ 
  - PHEV batteries  $\approx 10\%$  of EV-battery capacity
  - HEV batteries require even less capacity
- 1 million EVs would consume  $\approx 12,000$  tons of Li (without recycling); 1 million P/HEVs would consume  $\approx 1,200$  tons
- **Known** available supply of Li is over 200 billion tons, including from seawater
  - Each human being presently alive could own more than 2000 EVs, without recycling!



## BMS functionality

- BMS is interconnected with all battery-pack components and with host-application control computer. Functionality can be broken down into several categories:
- **Sensing and high-voltage control**  
Measure voltage, current, temperature; control contactor, pre-charge; ground-fault detection, thermal management
- **Protection against**  
Over-charge, over-discharge, over-current, short circuit, extreme temperatures

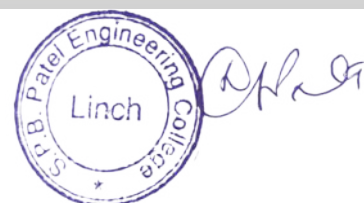
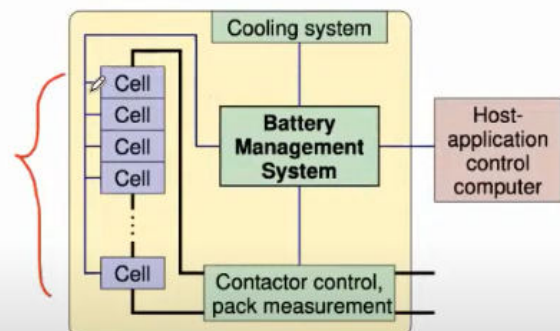

# Battery Pack With BMS

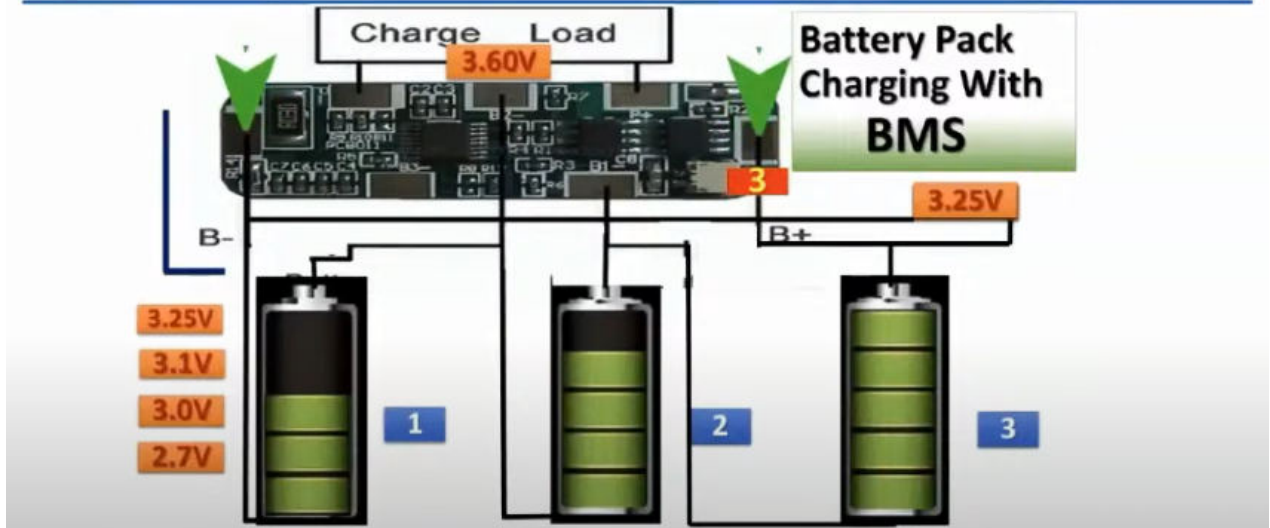

## Functionality

### 1) Sensing and high-voltage control

- Battery-pack sensing: Voltage
- Battery-pack sensing: Temperature
- Battery-pack sensing: Current
- High-voltage contactor control
- Isolation sensing ,
- Thermal management

### 2) Protection against

Over-charge, over-discharge, over-current, short circuit, extreme temperatures

3) Interface : Range estimation, communications, data recording, reporting

4) Performance management: State-of-charge (SOC) estimation, power-limit computation, balance/equalize cells

### 5) Diagnostics:

Abuse detection, state-of-health (SOH) estimation, state-of-life (SOL) estimation

## 1f. Thermal control

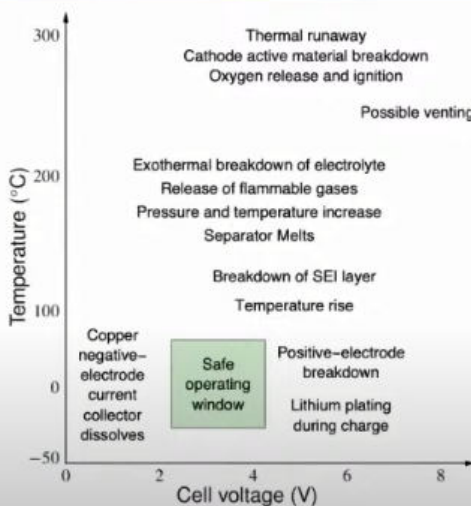

- Won't go into detailed thermal-management control strategy in this specialization
- However, important to understand safety and life impacts of temperature
- Generally, lithium-ion cells last longest if maintained in temperature band from about 10 °C to 40 °C during use
- Important to keep *uniform* temperature across battery pack for uniform aging

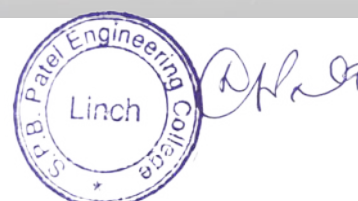

**Day:4 (30<sup>th</sup> DEC 2021)**

**NEW HORIZON**  
**COLLEGE OF ENGINEERING**  
DEPARTMENT OF AUTOMOBILE ENGINEERING  
*Presents*

**AICTE TRAINING AND LEARNING (ATAL) ACADEMY SPONSORED**  
**Five Days Online Faculty Development Program on**  
**"Electric and Hybrid Vehicle – Design, Integration and challenges"**  
27th Dec – 31st Dec 2021  
DAY 4 - 30TH DECEMBER

**9.30 - 11AM**  
**Sri Srivigraha Dasa**  
ISKCON

**11.30 am- 1 pm**  
**Dr. V. S. K. V. Harish**  
Asst.Professor,  
NSUT, Delhi

**2 pm- 3.30 pm**  
**Dr. Tushar Kanti Bera**  
Professor, NIT Durgapur

**Day:-4 Session:1 (Sri Srivigraha Dasa)**

**DISTRESS  
TO  
DE-STRESS**

Srivigraha Das...

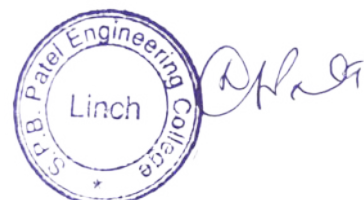

## What is stress?

Stress is what you feel when your body reacts to something it thinks is a threat. Your body starts to get ready to either fight or run away from, the threat. This causes changes in your body. This is known as the **'fight or flight'** reaction.

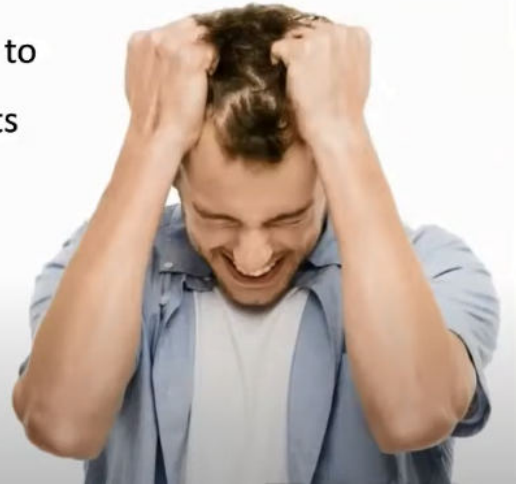

Day-to-day life

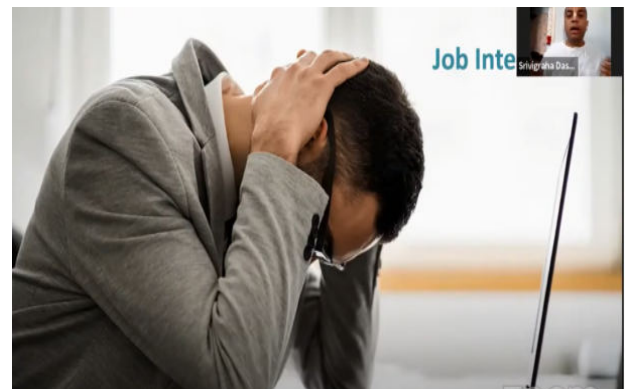

Job Interview

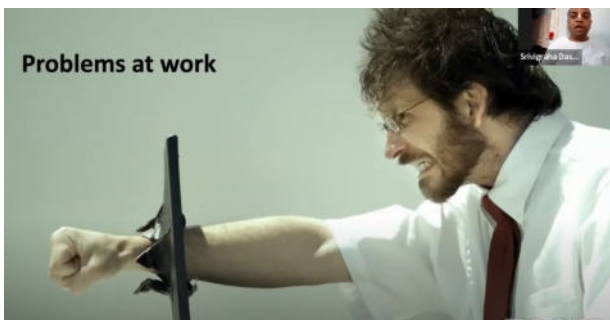

Problems at work



Exams



Dealing with Other people



Trying something new

Sir was told about how to reduce our stress, when and where it is generated, how to overcome, etc. Basically this session is about our day to day's problem and how to overcome it.

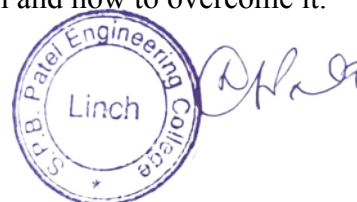



## Day:-4 Session:2 (Dr. V. S. K. V. Harish)



AICTE- ATAL sponsored



### "Electric and Hybrid Vehicles - Design, Integration and Challenges"

## Hybrid Electric Vehicles

by



**V.S.K.V. Harish, Ph.D.,** M-IEEE, M-ASHRAE

Department of Electrical Engineering  
Netaji Subhas University of Technology, Dwarka,  
New Delhi, India.

20<sup>th</sup> Dec'21

## Outline

### Agenda

1. Introduction to EVs.
2. Components of an Electric Car.
3. Electric Drive trains
4. Battery Parameters



## History of EVs

- 1874: David Salomons Rechargeable battery powered EV
- 1881: Frenchman Gustave Trouvé.
- DC motor fed by lead-acid batteries
- 1883: British Professors
- 1899 – 1912: The Baker Electric Inc.
- 1901: Lohner-Porsche Mixte (Hybrid EV)
- 1908 – 1912: Ford:- Model -T
- 1966: General Motors – Electrovan
- Lunar Roving Vehicle

# Benefits of EVs: Well to Wheel efficiency

## ICEs including Hybrids



## Electric Drive

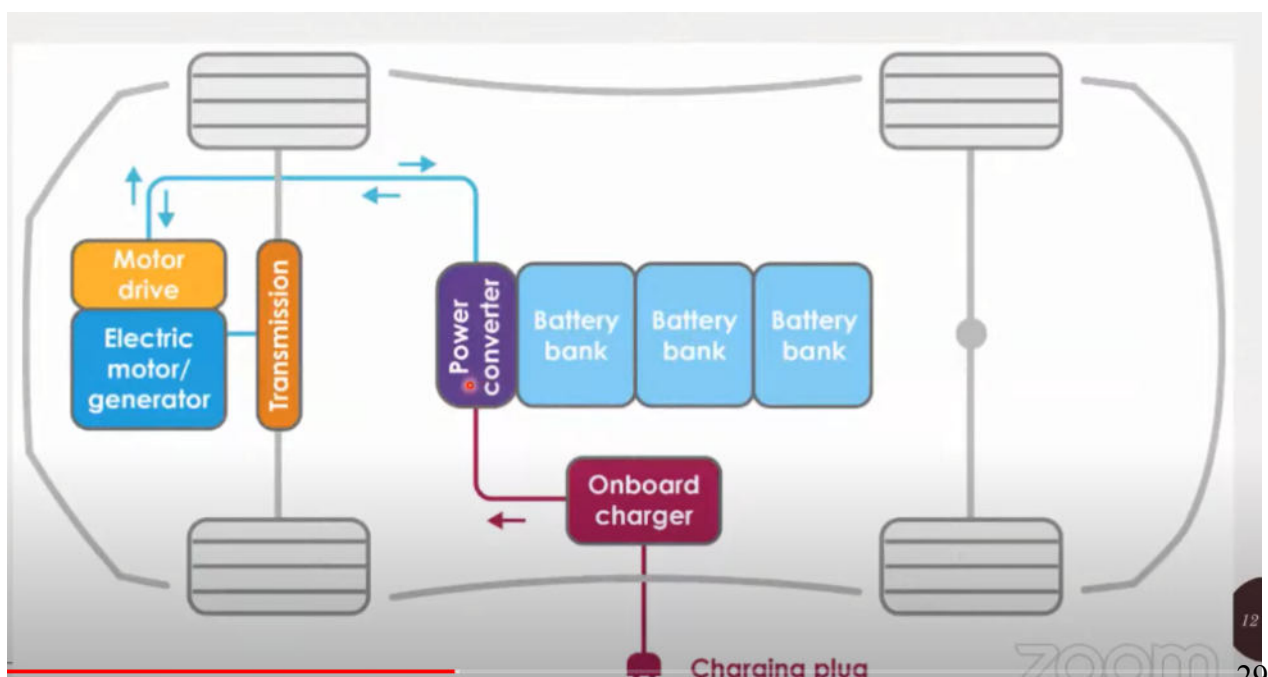
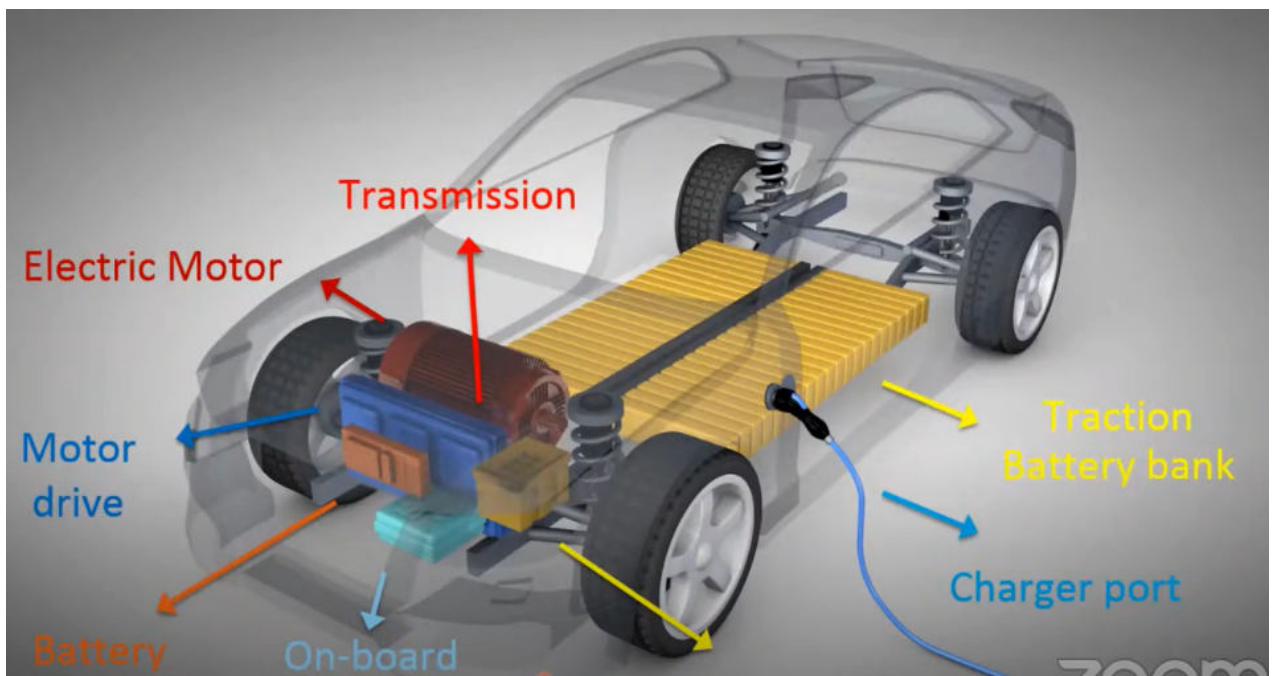



# Configuration of EV

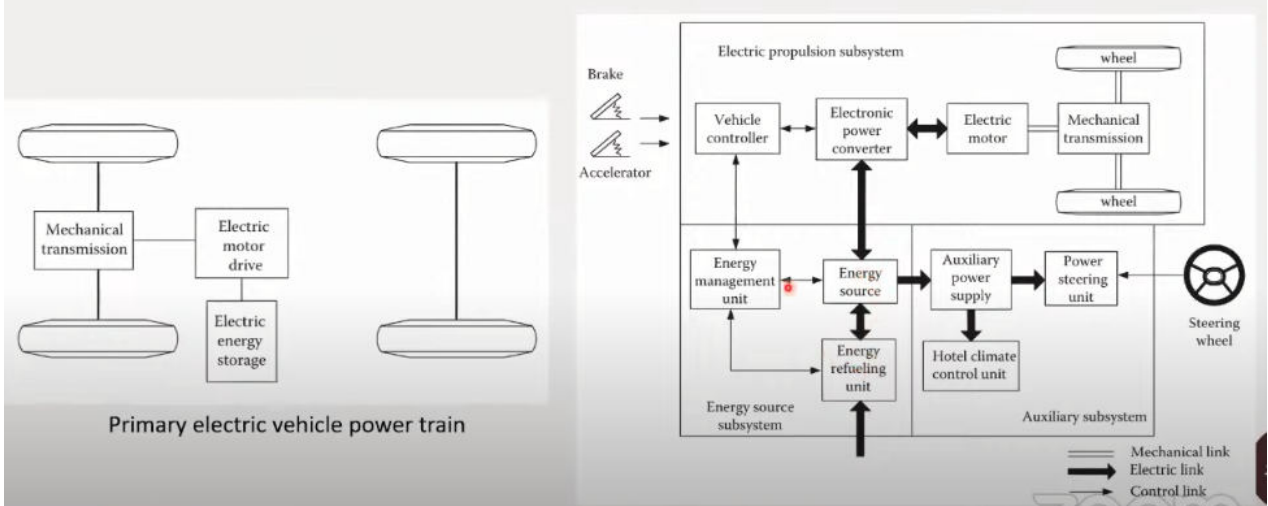

# Series hybrid electric drivetrain (electrical coupling)

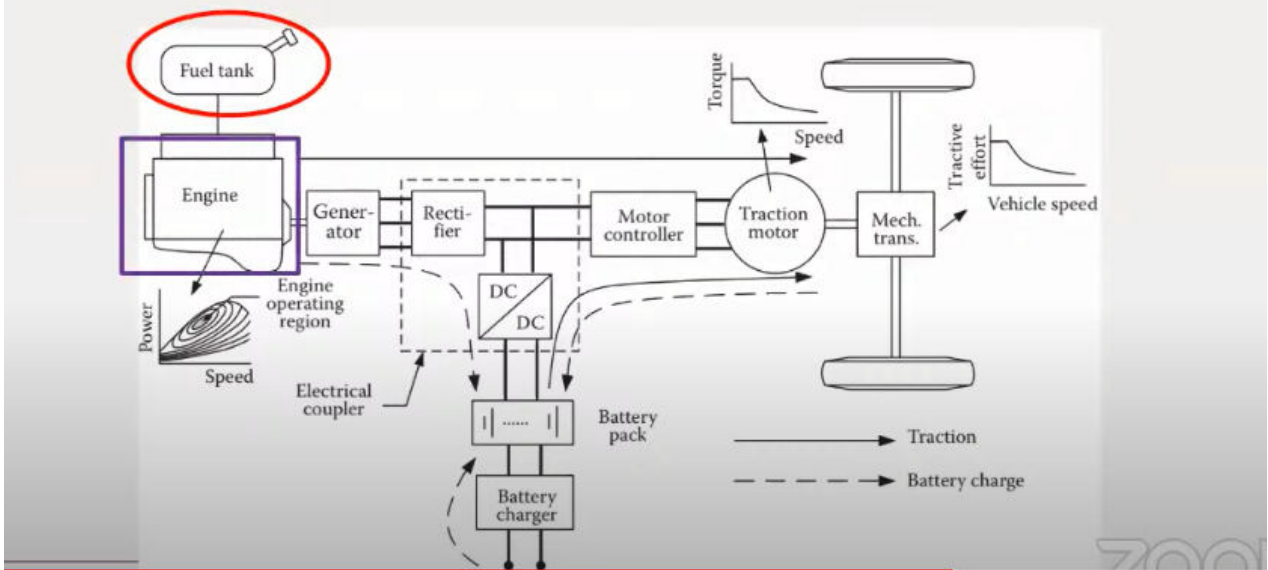

In this session, Sir mostly talked about history, types and basic design of ev's vehicle. As shown in the screen shot, Sir started with basic introduction, components of evs. Then after he gave detailed knowledge about different types of power train in case of hybrid systems. Also at last he explained about the parameters of the battery in detail.

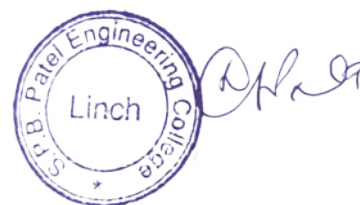

**Day:-4 Session:3 (Dr. Tusar Kanti Bera)**

He is the professor at NIT-Durgapur. Sir, mostly focused on the electrical equipment and its wiring method in the electrical vehicle.

**“Electric Vehicles (EV) Design Integration and Challenges: Impacts of BEVs and PHEVs and Research**

**Tushar Kanti Bera, B.E., M.Tech., Ph.D.**

Assistant Professor, Department of Electrical Engineering  
National Institute of Technology Durgapur (NITDgp), Durgapur, West Bengal, INDIA  
Email 1: [tkbera77@gmail.com](mailto:tkbera77@gmail.com), Mobile +91-9448853308



**PRESENTED AT: ATAL Academy sponsored 5-day Online FDP on “Electric & Hybrid Vehicles-Design, Integration and challenges”**



# Electric Vehicles (EVs)

## Electrical Power System

- Power System
  - Generation
  - Transmission
  - Distribution
  - Utilization

**Basic Structure of the Electric System**

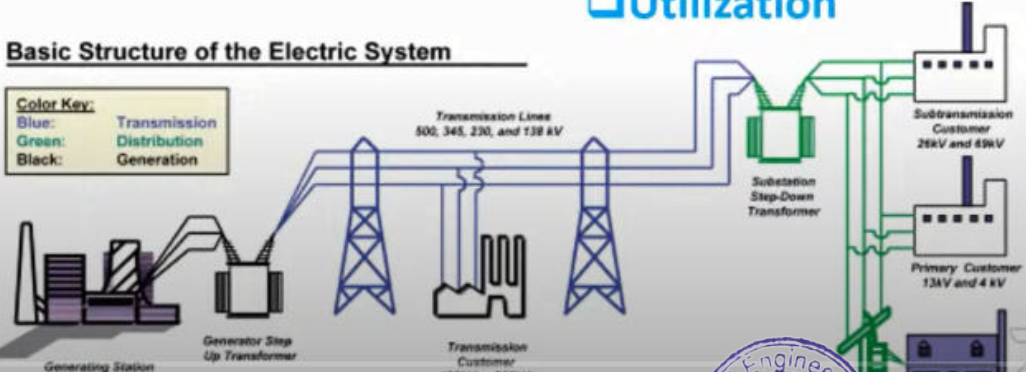

**Color Key:**  
Blue: Transmission  
Green: Distribution  
Black: Generation

Generating Station → Generator Step Up Transformer → Transmission Lines (500, 345, 230, and 138 kV) → Substation Step-Down Transformer → Subtransmission Customer (26kV and 89kV) → Primary Customer (13kV and 4 kV)

S. B. Patel Engineering College  
Linch  
*Dr. K. S. J.*

# Impedance Based Monitoring: Electrical Impedance (Z)

- In AC circuit, the conducting material produces an electrical property, called Impedance (Z) to opposes the alternating current flow through the conductor.

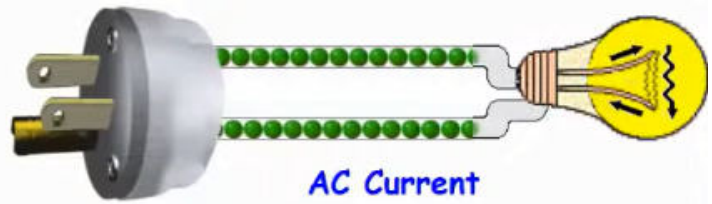

- Amplitude: **Varies over t**

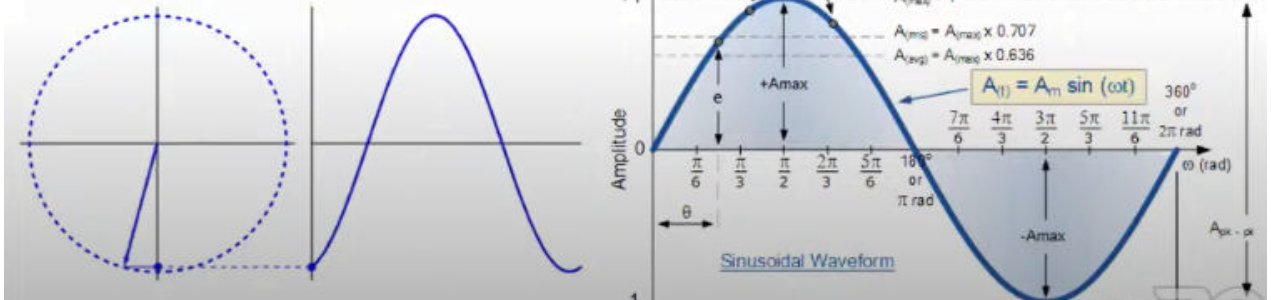

## What Battery is More Powerful?

- Battery 1: 12 V, 100 Ah
- Battery 2: 24 V, 100 Ah
- Energy for Battery 1:  $12 \text{ V} \times 100 \text{ Ah} = 1200$  (?) unit
- Energy for Battery 2:  $24 \text{ V} \times 100 \text{ Ah} = 2400$  (?) unit



12 V, 100 Ah



24 V, 100 Ah

- Battery bank: Series

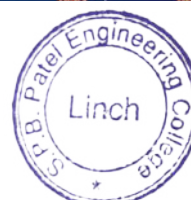

*Handwritten signature*

**Day:5 (31<sup>st</sup> DEC 2021)**

**NEW HORIZON**  
**COLLEGE OF ENGINEERING**  
DEPARTMENT OF AUTOMOBILE ENGINEERING  
*Presents*

AICTE TRAINING AND LEARNING (ATAL) ACADEMY SPONSORED  
Five Days Online Faculty Development Program on  
"Electric and Hybrid Vehicle – Design, Integration and challenges"  
27th Dec – 31st Dec 2021  
DAY 5 - 31st DECEMBER

**9.30AM - 11.00AM**  
Mr. P. Rajendran,  
Head of Department,  
External Training  
Programmes, Nandi  
Toyota

**11.30AM - 1.00PM**  
Mr. Aruli Umapathy  
Project Associate, IIT  
Madras

**VALEDICTORY FUNCTION**

**3.00 PM**  
VALEDICTORY GUEST  
K JAYANNA  
Former executive , Bosch ltd  
R & D department , Bengaluru

**Day:-5 Session:1 (Mr. P Rajendran)**

SAVE OUR PLANET

**WELCOME**  
**To**  
**Electric Vehicle**  
**Technology**  
**By**  
**P Rajendran**  
**Nandi Toyota, Bangalore**  
**7892792323**  
**prajgoit@gmail.com**

zoom

He is the head of the department of external training of Toyota company. He started the session with the national Anthem and then provided detailed knowledge about the toyota electric car from its history to present and to the future.





## Contents

1. History of Toyota Hybrid System
2. THS System Function and Components.
3. Demo on Hybrid Car
4. Demo on Hybrid Simulators
5. Videos- THS & Pollution

## History of Hybrid Vehicle Prius



- ▶ Concept car for the Tokyo Motor show:
- ▶ Single Motor
- ▶ DI
- ▶ CVT
- ▶ Capacitor Instead of Batteries.
- ▶ Fuel Efficiency Targeted 30 Kmpl.
- ▶ EMS ( Energy Management System), Technically Hybrid



## First Generation Prius



NHW10 (1997-2000)



NHW11 (2000-2003)



Gasoline Vehicle Vs Hybrid Vehicle (Mileage )				
Vehicle Type	Engine Capacity	Mileage (ARAI)	Mileage Comparison	Reduction of CO2 Emission
Gasoline (Corolla - 2010)	1794 cc	10.21 Kmpl (Manual) & 9.8 Kmpl ( Automatic)		
Hybrid ( Prius 3rd Gen- 2009)	1798 cc	23.91 Kmpl ( Automatic)	2.44 times of Gasoline (IC Engine)	59%
Hybrid ( Prius 4th Gen 2015)	1798 cc	26.27 Kmpl ( Automatic)	2.68 times of Gasoline( IC Engine)	62.70%
Hybrid ( Prius 4th Gen 2015)	1798 cc	If 40 Kmpl as Toyota claims	4.08 times of Gasoline( IC Engine)	75%

## How Toyota Achived ? What was the approach

- ▶ 1. THS
- ▶ 2. Synergy Drive
- ▶ Selection of Gasoline engine with Dual VVT-i & Atkinson Cycle
- ▶ Avoid Draining Engine power -No belt driven HVAC Compressor ,Power steering Pump, Water Pump and Alternator
- ▶ Regenerating Brake system / Charging while driving down the hill and more usage of R- brake than Hydrolic.
- ▶ While applying brake, the system uses regenerating brake more than Convention hydraulic brake.

Then he provided detailed information about the types of hybrid vehicles with its advantages and disadvantages. He explained each and every component of the hybrid system in detail. He shared one video in which he explained all components with a physical prototype.

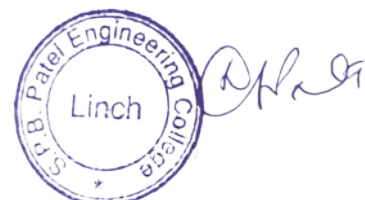



## VISION OF NANDI TOYOTA

To be the most admired fastest growing innovative corporate house committed to CUSTOMERS, EMPLOYEES, SHAREHOLDER & SOCIETY.

## THANK YOU

P RAJENDRAN  
HOD AUTOMOBILE  
NANDI VISHWAVIDYALAYA  
NANDI TOYOTA  
+91 7892792323/9449219364  
[prajgoit@gmail.com](mailto:prajgoit@gmail.com)



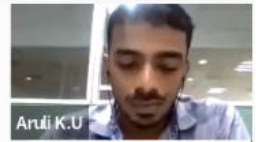

# THERMAL MANAGEMENT OF EV MOTORS AND CONTROLLERS

- ARULI UMAPATHI,  
IIT MADRAS

Each component has its limit

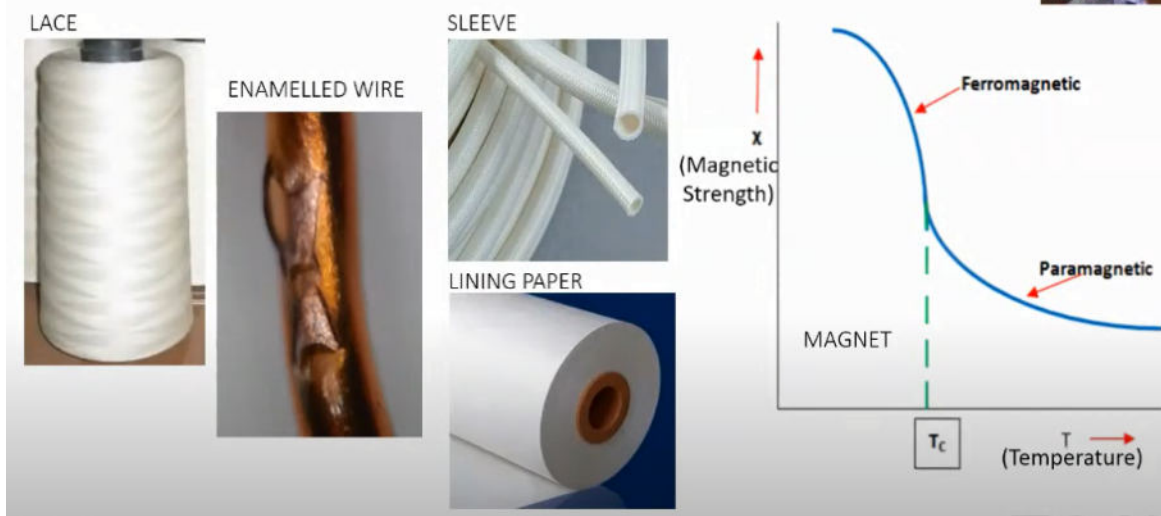

Day 5's last session was delivered by Mr. Aruli Umapathy. Sir mostly talked about component material, its limitations and alternatives used in evs. Also he gave detailed knowledge about selection of material for each component used in this electrical vehicle.

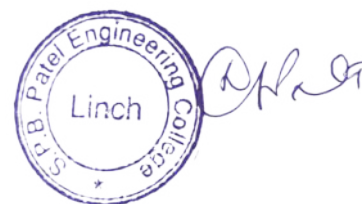



# LOSSES IN MOTOR



CEET 5kW MOTOR V-01

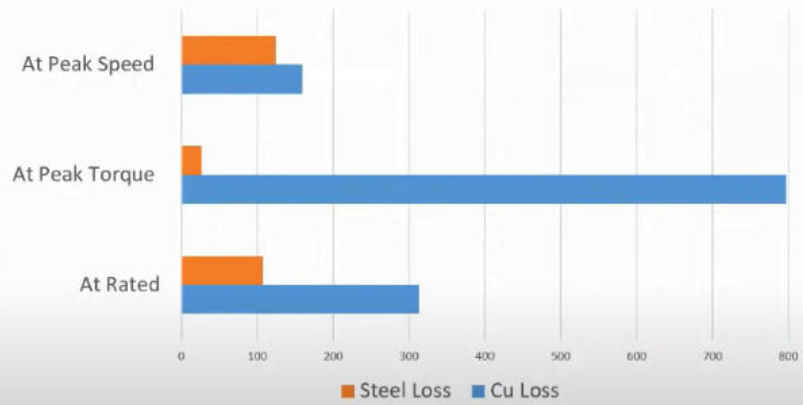

# Thermal Circuit

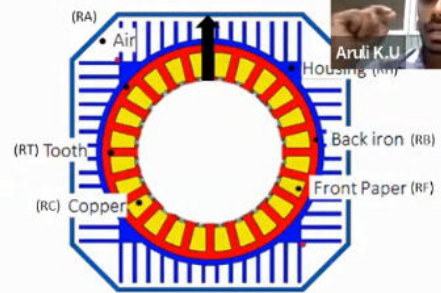

MOTOR CROSS SECTION

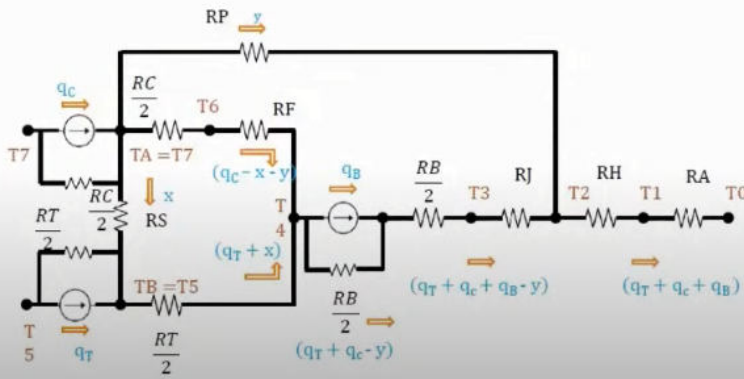

Basically all information shared by sir was about thermal analysis of each and every material in detail which was his project in phd period.

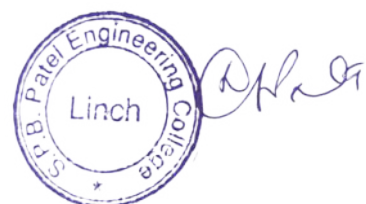

## Conclusion

Overall sessions were nice. It gives me an opportunity to learn. As someone truly said that if you stop learning, then you cant be able to teach anymore. Such opportunities provided by the institute are a good initiative. I am thankful to the institute for allowing me to attend this Faculty Development Program.

Yours Sincerely,

---

**Prof. Divyang Patel**  
**Assistant Professor, Mechanical Engineering Department**

---

**Approved By**  
**Prof. Chitrlekha Nahar**  
**HoD of Mechanical & Automobile Engineering Department**

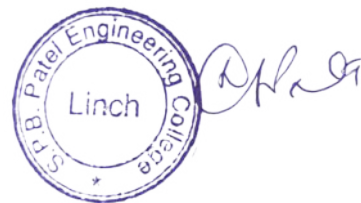



# SAFFRONY INSTITUTE OF TECHNOLOGY S.P.B. PATEL ENGINEERING COLLEGE

SIT/SPBPEC/ADMIN/FDP/2022/ 27

Date: 17-01-2022

To

Dr. R Rajendran  
The Coordinator  
FDP -124  
National Institute of Technical Teachers  
Training and Research,  
Taramani, Chennai - 600113

Sub: Relieving Letter of Prof. Avani Dedhia for attending FDP-124 on 'Guidance and Counselling'

Dear Sir,

This is to convey that Prof. Avani Dedhia, Assistant Professor in Civil Engineering Department, S. P. B. Patel Engineering College, Mehsana, Gujarat is deputed for attending the FDP- 124 on 'Guidance and Counselling' organized by NITTTR – Chennai from 17<sup>th</sup> Jan to 21<sup>st</sup> Jan, 2022. She is relieved from her duties from 17<sup>th</sup> Jan to 21<sup>st</sup> Jan, 2022 to attend this FDP.

Thanking you,

  
Principal/Registrar,





S.P.B. PATEL  
ENGINEERING COLLEGE  
SAFFRONY INSTITUTE OF TECHNOLOGY CAMPUS

# Management Development Programme CERTIFICATE PROGRAM



Mr. Dhiren Parekh



06-08 SEP 2021



10:00 AM

[www.saffrony.ac.in](http://www.saffrony.ac.in)



Seminar Hall,  
Saffrony Institute of India, Mehsana

**AICTE Training and Learning  
(ATAL) Academy Sponsored  
One Week Faculty Development  
Programme (FDP) on  
“Smart & Sustainable  
Infrastructure Development  
for New India”**

**20- 24 December, 2021**

**About FDP**

By 2030 it is predicted that 68 Indian cities will each have more than one million inhabitants, and six megacities, more than ten million each. The rapid growth of cities causes a large number of challenges, including insufficient power supply, unreliable public transportation systems and limited access to adequate medical treatment. To meet the challenges of continuing growth without destroying the environment, infrastructure planning for smart and sustainable development is crucial. The training program is planned to bring on a common platform to share and discuss the on-going technical advancement, constraints and other significant issues of Sustainable technologies for infrastructure Development

**Course Contents**

- ✓ Innovation in Infrastructure
- ✓ Sustainable construction practices
- ✓ Sustainable construction materials & technology
- ✓ Technologies for Smart city development
- ✓ Urban mobility & Intelligent Transport Systems
- ✓ Waste to Energy Management
- ✓ Technologies related to Sanitation
- ✓ Building Smartly- Affordable & Green Building Technologies for Cities
- ✓ Smart solutions for construction management

**Expected Outcomes**

Insights in recent development in sustainable and smart infrastructure technologies & engineering. Participants will be having the opportunity for dissemination of information and technology, sharing of expertise and exchange of views related to sustainable resource management. Participants will be able to enhance knowledge in Smart Water and Waste Management, Smart Environment, Smart Urban Planning, Smart Buildings & Clean Energy.

**About Institute**

Birla Vishvakarma Mahavidyalaya Engineering College (BVM) is a Premier Institution of CVM established in 1948 with the Motto of “Work is Worship”. We are the First Approved Degree Engineering College of the Gujarat State. More than 20000 engineers have been graduated from this college spread across the globe. BVM is the first Autonomous Institute of Gujarat State. It offers B.Tech, M.Tech. and Ph.D. Degree Programmes. The College is affiliated with the Gujarat Technological University. The most striking feature of BVM is the dedicated and experienced faculty base and most of the Programs are NBA Accredited.

**About Organizing Department**

The Departments of Structural Engineering is one of the most efficient departments of BVM Engineering College and offers M.Tech and B.Tech programs. The department has highly qualified, well-experienced and dedicated faculty members. The department is equipped with advanced instruments and equipment for research facilities. Experts from leading industries and educational institutes are invited frequently for guest lectures on recent developments for the benefit of students and staff. The department is deeply involved in testing and consultancy work besides quality research.

**About AICTE Training and Learning  
(ATAL) Academy Sponsored**

All India Council for Technical Education (AICTE) through its newly established AICTE Training And Learning (ATAL) Academy have started unique faculty development programs in various thrust areas of modern technology. 200 such programs have already been conducted in various government institutions benefitting around 10,000 faculties, research scholars & PG students during the FY 19-20. Seeing the success of this initiative, AICTE Training And Learning (ATAL) Academy has announced to organize 500 AICTE Training And Learning (ATAL) Academy FDPs across the country for FY20-21. Accordingly, AICTE Training And Learning (ATAL) Academy is inviting a proposal for the conduction of these Faculty Development programs (FDP) in various thrust areas and emerging areas.

**Who can attend?**

Faculty from AICTE Approved Academic institutions/ Universities, Research Scholar/ Industry personnel/Professionals and others are invited.

**No Registration Fees.**

**FDP will be conducted on OFFLINE.**

**Resource Persons**

Experts from Premier organizations and Professionals will conduct the sessions.

**For Registration**

<https://atalacademy.aicte-india.org/signup>

For Further Information

Kindly contact **Prof. Jagruti Shah, Coordinator**

**Email: [jagruti.shah@bvmengineering.ac.in](mailto:jagruti.shah@bvmengineering.ac.in)**

**Con No: +91 9714073963**



AICTE Training and Learning (ATAL) Academy Sponsored  
One Week Faculty Development Programme (FDP) on  
**“Smart & Sustainable  
Infrastructure Development for New India”**  
20- 24 December, 2021





# 10 DAYS VIRTUAL FACULTY DEVELOPMENT PROGRAMME (FDP)

ON

## Facilitating Digital Transformation in Design, Construction and Management Processes of Civil Engineering

21<sup>st</sup> February 2022 to 2<sup>nd</sup> March 2022

### GUEST SPEAKERS



Dr. Peter Demian  
Professor and Head  
Loughborough University, UK



Dr. Amarnath C B  
Head, BIM Strategies, L&T  
Constructions



Dr. Kriti Ruikar  
Associate Professor,  
Loughborough University, UK



Prof P.Ratish Kumar  
Head, Civil Engineering,  
NIT Warangal



Dr. Kiran Kumar DEVS  
Researcher, NTU Singapore



Dr. Prashant Anand  
Asst. Professor, IIT Kharagpur



Dr. Sparsh Johari  
Asst. Professor, IIT Guwahati



Mr. Ashwani Kumar Jha  
Senior Automation Engineer,  
Motto McDonald, Bengaluru

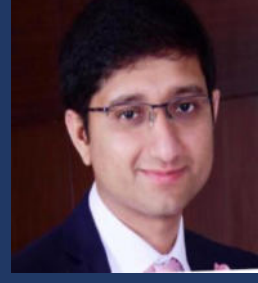

Mr. Abhiram Shankar  
Construction Manager,  
RMB Groups, UAE



Mr. Prasad S  
Manager, L&T  
Construction, Chennai



Dr. K. M. Nanthan  
Project Manager, L&T  
constructions, Chennai



Mr. Arunkumar R  
Global Manager, Bentley  
Systems



Dr. Akshay V  
Asst. Professor, BITS Pilani, UAE



Dr. P Ravi Prakash  
Asst. Professor, IIT Jodhpur



Mr. Pratap Vasipalli  
Senior Consultant, KPMG



Mr. Atanu Saha  
Planning Lead, L&T  
Construction, UAE



Dr. Ahad Javanmardi  
Postdoc Researcher, Fuzhou  
University, China



Mrs. Vandana P  
Project Manager, Community  
Design Agency, Mumbai



Ms. Priyadarshini Das  
Researcher, Western Sydney  
University, Australia



Mr. Nithin P  
Project Management  
Professional, IIM Bengaluru



Mr. Anil Kumar PM  
PM Research Fellow  
IIT Madras



Dr. Rahul T  
Asst. Professor,  
NIT Warangal



Dr. R Ramesh Nayaka  
Asst. Professor,  
NIT Warangal



Dr. MVN Siva Kumar  
Asst. Professor,  
NIT Warangal



Dr. T P Tezeswi  
Asst. Professor,  
NIT Warangal



Dr. K Gopi Krishna  
Asst. Professor,  
NIT Warangal

Coordinators: **Dr. R. Ramesh Nayaka and Dr. M.V.N. Sivakumar**, Assistant Professors, Department of Civil Engineering, NIT Warangal

For more information: <https://www.nitw.ac.in/eict/fdtcenit1.php>

Registration Link : <https://forms.gle/Sh4XS9t7dDV4XC796>

Organized by

Department of Civil Engineering, NIT, Warangal in association with Electronics and ICT Academy, NIT, Warangal

[Sponsored by Ministry of Electronics and Information Technology, (MeitY), GOI]



## CERTIFICATE OF COMPLETION

THIS IS TO CERTIFY THAT DR./PROF./MR./MS.

**AVANI K DEDHIA**

Has Successfully Completed Instructor-Led Live Online  
10-Days Faculty Development Program / Short Training on  
**Applied Data Science using Python Programming and Excel**

From 17th June to 29th June, 2020

Organized by

**EduxLabs (Esoir Business Solution LLP)**

ISSUED ON:  
**29TH JUNE 2020**



Esoir Business Solution LLP  
  
MD. NAFISH Director  
EDUXLABS DIRECTOR  
(ESOIR BUSINESS SOLUTION)





**ELECTRONICS & ICT ACADEMY**  
**NATIONAL INSTITUTE OF TECHNOLOGY WARANGAL, (T.S.), INDIA**



and  
**Department of Civil Engineering, NITW**

**Participation Certificate**

This is to certify that **MEET MANISHKUAR JANI, Assistant Professor**  
from **S.P.B.PATEL ENGINEERING COLLEGE, AHMEDBAD, GUJARAT**

has participated in a 40-hour (10 days) Online Faculty Development Programme (FDP) on  
**"FACILITATING DIGITAL TRANSFORMATION IN DESIGN, CONSTRUCTION AND MANAGEMENT PROCESS OF CIVIL ENGINEERING"** Sponsored by Ministry of Electronics and Information Technology (MeitY), GoI organized by Department of Civil Engineering, NITW and E&ICT Academy, NIT Warangal during February 21<sup>st</sup> - 2<sup>nd</sup> March, 2022.

She/He has successfully completed all the requirements for the completion of the programme.

**Dr. R. Ramesh Nayaka**  
Coordinator  
NIT, Warangal

**Dr. M. V. N. Siva Kumar**  
Coordinator  
NIT, Warangal

**Dr. Ratish Kumar Pancharathi**  
Head, Dept. of Civil Engineering  
NIT, Warangal

**Prof. R.B.V. Subramaanyam**  
Chief Investigator  
E&ICT Academy, NIT, Warangal

**Prof. N.V. Ramana Rao**  
Director  
NIT, Warangal

## MANAGEMENT DEVELOPMENT PROGRAMME REPORT

### Program Details:

🚦 **Program Name:** Management Certificate Program

🚦 **Duration:** 3 days

🚦 **Modules:**

1. Basic Management Skills
2. Coaching for Improved Performance
3. Conflict Resolution Strategies

**Organizer:** S.P.B. Patel Engineering College

**Date:** 6-8 September 2021

**Location:** S.P.B. Patel Engineering College

**Expert:** Mr Dhiren Parikh

**Number of Participants:** 75

### Program Overview:

The Management Certificate program at S.P.B. Patel Engineering College aimed to equip participants with essential skills for leadership roles. Over three days, faculties delved into various aspects of management, focusing on transitioning into managerial roles, managing people and tasks effectively, aligning individual and company goals, and resolving conflicts in the workplace.

This Certificate Program teaches employees how to:

- transition from worker to supervisor/manager

- manage work and people
- plan for achievement of results
- align individual performance goals with the company's goals
- coach employees' performance to achieve company goals and objectives
- become self-aware in order to effectively communicate with different personality types
- learn how to flex your management style to the needs of your individual team members
- resolve conflicts in order to focus on results and promote teamwork

The Management Development Certificate Program is a comprehensive training program that consists of three different learning modules. Each module is 8 hours / 1 day in length for a total of 24 hours or 3 full days.

### **Day 1: Basic Management Skills**

The first day of the program emphasized mastering fundamental management skills such as planning, problem-solving, decision-making, organizing, delegation, communication, and goal alignment. Participants learned how to lead teams and manage tasks efficiently to drive business growth.

Key Takeaways:

- Understanding the importance of effective planning and organization
- Developing skills in decision-making and delegation
- Enhancing communication techniques for better team coordination

### **Day 2: Coaching for Improved Performance**

Day two focused on coaching techniques to enhance employee performance in today's dynamic work environment. Participants explored ways to motivate employees and foster excellence in job performance through effective coaching strategies.

Key Takeaways:

- Learning different coaching styles and when to apply them
- Developing skills in providing constructive feedback
- Understanding the role of coaching in driving employee engagement and productivity

### **Day 3: Conflict Resolution Strategies**

The final day addressed conflict resolution as an essential skill for working in teams. Participants learned to identify, assess, and resolve conflicts, fostering a collaborative work environment conducive to productivity and teamwork.

Key Takeaways:

- Understanding the root causes of conflicts in the workplace
- Developing techniques for de-escalating conflicts and finding mutually beneficial solutions
- Building skills in communication and empathy to facilitate conflict resolution

**Participation Activities:**

Participants engaged in interactive activities, discussions, and role-plays to apply the concepts learned during the program actively.

**Feedback:**

Feedback from participants highlighted improvements in job skills and performance, along with ideas for continuous improvement in managerial roles.

**Conclusion:**

Overall, the Management Certificate Program provided participants with practical tools and strategies to excel in leadership positions, contributing to organizational success and personal growth.